



Toase-eh Park Sanati Gohar Ofogh
Petrochemical Co.
**CONCEPTUAL, BASIC and DETAIL DESIGN
ENGINEERING OF STYRENE PARK OFFSITE**



Document Title: Site Run Test Procedure

Document No.: EI027-DMF-VD-QC-PRO-031

Rev. R0

Page 1 of 10

STYRENE PARK OFFSITE

**Document Title:
Site Run Test Procedure**

R0	08-Oct.-2024	IFA	A.Parsafar	A.Shadmand	M.Heidarzadeh
Rev.	Issued Date	DESCRIPTION	PREPARED	CHECKED	APPROVED



Toase-che Park Sanati Gohar Ofogh
Petrochemical Co.
**CONCEPTUAL, BASIC and DETAIL DESIGN
ENGINEERING OF STYRENE PARK OFFSITE**



Document Title: Site Run Test Procedure

Document No.: EI027-DMF-VD-QC-PRO-031

Rev. R0

Page 2 of 10

REVISION RECORD SHEET

Page	Revisions							Page	Revisions						
	R0	R1	R2	R3	R4	R5	R6		R0	R1	R2	R3	R4	R5	R6
1	X							41							
2	X							42							
3	X							43							
4	X							44							
5	X							45							
6	X							46							
7	X							47							
8	X							48							
9	X							49							
10	X							50							
11								51							
12								52							
13								53							
14								54							
15								55							
16								56							
17								57							
18								58							
19								59							
20								60							
21								61							
22								62							
23								63							
24								64							
25								65							
26								66							
27								67							
28								68							
29								69							
30								70							
31								71							
32								72							
33								73							
34								74							
35								75							
36								76							
37								77							
38								78							
39								79							
40								80							





 	Toase-eh Park Sanati Gohar Ofogh Petrochemical Co. CONCEPTUAL, BASIC and DETAIL DESIGN ENGINEERING OF STYRENE PARK OFFSITE	 
	Document Title: Site Run Test Procedure	
	Document No.: EI027-DMF-VD-QC-PRO-031	Rev. R0 Page 3 of 10

TABLE OF CONTENTS

1.0 PURPOSE

2.0 SCOPE

3.0 REFERENCES

4.0 RESPONSIBILITY

5.0 SEQUENCE OF WORK

6.0 EQUIPMENT START UP

7.0 CONTROL OF FAN SPEED





8.0 CONTROL OF MOTOR SPEED

9.0 NOISE LEVEL TEST

10.0 VIBRATION MEASUREMENT PROCEDURE

11.0 AIR FLOW TEST

12.0 SAMPLE OF RUN-IN TEST RECORD SHEET

 	Toase-eh Park Sanati Gohar Ofogh Petrochemical Co. CONCEPTUAL, BASIC and DETAIL DESIGN ENGINEERING OF STYRENE PARK OFFSITE	 	
	Document Title: Site Run Test Procedure		
	Document No.: EI027-DMF-VD-QC-PRO-031	Rev. R0	Page 4 of 10

1. PURPOSE

This procedure defines the methods of Site Mechanical Run-In Test Procedure FOR **Toase-eh Park anati Gohar Ofogh Petrochemical Co. CONCEPTUAL, BASIC and DETAIL DESIGN ENGINEERING OF STYRENE PARK OFFSITE PROJECT**, and define measured data when RUN-IN TEST be necessary according to contract of project for Air cooled heat exchangers of which will be fabricated and assembled in DAMAFIN Co.

2. SCOPE

This procedure included the key elements of **Control of the fan and motor speed, vibration, noise and air flow.**

3. REFERENCES

- 3.1. API STANDARD 661 SEVENTH EDITION, JULY 2013 REAFFIRMED, JUNE 2018
- 3.2. INSTALLATION, OPERATION & MAINTANENCE (MANUAL): EI027-DMF-VD-ME-MNL-032
- 3.3. Data Sheets and Drawings

4. RESPONSIBILITY





This procedure is managed by the Quality Engineering Department of Damafin.

5. SEQUENCE OF WORK

The run-in test shall be performed on assembled bays including the completed tube bundle/header box assembly, louvers (if applicable), plenums, fan rings, fans, drivers, drive assemblies, motor mounts and support columns.

5-1-Steel work assembly

- Columns
- Beams
- Bracings
- Truss
- Plenum

 	Toase-eh Park Sanati Gohar Ofogh Petrochemical Co. CONCEPTUAL, BASIC and DETAIL DESIGN ENGINEERING OF STYRENE PARK OFFSITE	 	
	Document Title: Site Run Test Procedure		
	Document No.: EI027-DMF-VD-QC-PRO-031	Rev. R0	Page 5 of 10

- Fan ring
- Motor support UPNs
- Housing
- Bundle

5-2-The run-in test shall consist of the following

- a) Check and record the fan tip clearances;
- b) Set and record the fan blade pitch as per design blade angle ($\pm 0.5^\circ$ blade angle);
- c) Check and record the radial run-out tolerance for the fan shafts;
- d) Check and record the radial and axial run-out tolerances for the sprockets attached to the fan shafts;
- e) Run the motors and fans at the design speed for a minimum of 15 minutes, recording the motor voltage, motor amperage, fan speed, and vibration level (see API para 7.3.2.1);
- f) Air flow measurements shall be taken for each fan. (See Annex D).
- g) Checking bearings temperature

5-3- Electrical Equipment





- Installation of vibration switch
- Motor

5-4-Mechanical equipment assembly

- Pulley
- Installation of fans & Belt (1 set / Tube bundle)
- Installation of auxiliary parts (which are supplied by DAMAFIN) for installing motors.

6- Equipment starts up:

- Check the exact alignment of mounting and shaft. Checking lubrication before start up

 	Toase-eh Park Sanati Gohar Ofogh Petrochemical Co. CONCEPTUAL, BASIC and DETAIL DESIGN ENGINEERING OF STYRENE PARK OFFSITE	 	
	Document Title: Site Run Test Procedure		
	Document No.: EI027-DMF-VD-QC-PRO-031	Rev. R0	Page 6 of 10

- Avoid resonance of the base with the turning frequency Turn the rotor by hand.
- Check the direction of rotation.
- Turn the rotor by hand. Check the direction of rotation.
- Turn the motors on and check before connect any part.

7. CONTROL OF FAN SPEED

Rotate fan by hand and check tip clearance between blade and fan ring according to below table.





RPM of fan in coupled situation shall be checked by using digital RPM meter in 5 stages and every 3 minutes.

Record pitch of each fan blade of Manually adjustable pitch fan

-Auto variable fan to be checked especially for their actuator operation (every 2 minutes) for each fan.

Radial Clearances

Fan Diameter		Radial Clearance	
M	ft.	Minimum	Maximum
≥ 1.0 and ≤3.0	>3 and <9	6.35 mm (1/4 in)	12.7 mm (1/2 in)
>3.0 and <3.5	>9 and < 11	6.35 mm (1/4 in)	15.9 mm (5/8 in)
>3.5	>11	6.35 mm (1/4 in)	19.05 mm (3/4 in)

 	Toase-eh Park Sanati Gohar Ofogh Petrochemical Co. CONCEPTUAL, BASIC and DETAIL DESIGN ENGINEERING OF STYRENE PARK OFFSITE	  
	Document Title: Site Run Test Procedure	
	Document No.: EI027-DMF-VD-QC-PRO-031	Rev. R0 Page 7 of 10

8. CONTROL OF MOTOR SPEED

Control of motor speed shall be done in uncoupled situation in 5 stages and every 3 minutes and AMP, RPM and bearing temperature to be measured for each electromotor.

9. Noise Level Test:

DAMAFIN guarantees the noise level will not exceed that specified in data sheets.

Noise level shall be measured by a device at one meter distance from air cooler in three points; under, beside and above the bay which is shown below and in 5 stages. (Figure1)

All the information Will be written down in run-in test report (please refer to attachments).



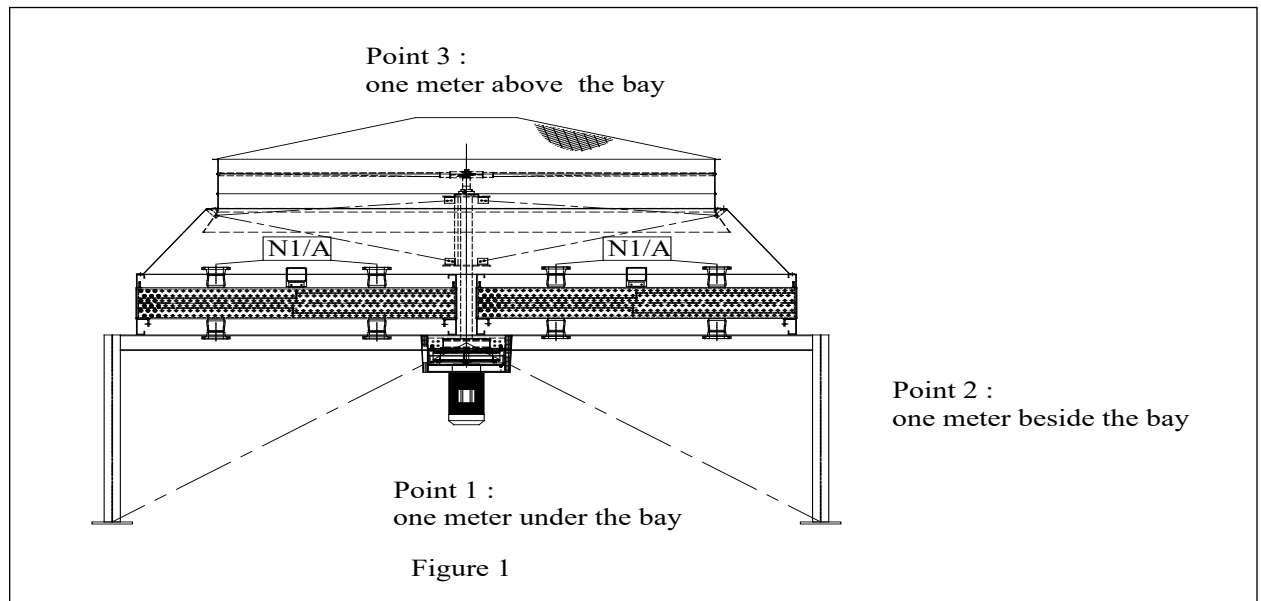

Measured values shall be less than Max (85 dB).



10. Vibration Measurement Procedure:

Checking of the structure and mechanism vibrations in conformity with the applicable code or the fan supplier's requirements.

Simulate transmitter by using a hammer:

 	Toase-eh Park Sanati Gohar Ofogh Petrochemical Co. CONCEPTUAL, BASIC and DETAIL DESIGN ENGINEERING OF STYRENE PARK OFFSITE	  	
	Document Title: Site Run Test Procedure		
	Document No.: EI027-DMF-VD-QC-PRO-031	Rev. R0	Page 8 of 10

local artificial shock should be implemented to structure parts and performance of vibration transmitter system should be checked and run-in test report should be filled up.

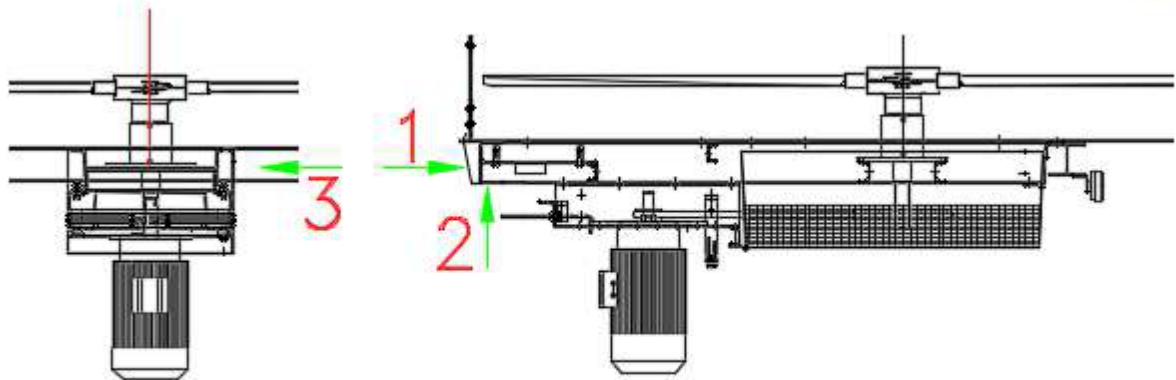

Points of vibration measuring shall be minimum 3 points (are shown above), each point related to one direction. For each measuring item, RMS and peak to peak shall be recorded.

The maximum amplitude of vibration over the design fan-speed range shall be 0.15 mm (0.006 in.) from peak to peak, as measured on primary structural members and machinery mountings.





11.0. AIR FLOW TEST

The speed of air that blow form fan and then over the tube bundle shall be measured and compared with related data in API data sheets.

11.1. Air Velocity

11.2. Determining Plane of Velocity Measurements

Air velocity measurements should be taken in a plane parallel to the fan. For a forced draught unit, this plane should be below the fan, as close as possible to the fan ring or inlet bell to negate the effects of ambient wind. For an induced draught unit, this plane should be above the fan and as close to the fan as possible to negate the effects of ambient wind. The anemometer is held parallel to the plane of the fan during the reading. The velocity reading

 	Toase-eh Park Sanati Gohar Ofogh Petrochemical Co. CONCEPTUAL, BASIC and DETAIL DESIGN ENGINEERING OF STYRENE PARK OFFSITE		 	
	Document Title: Site Run Test Procedure			
	Document No.: EI027-DMF-VD-QC-PRO-031		Rev. R0	Page 9 of 10

can be affected by the yaw of the fan. If the angle between the observed direction of air flow and the anemometer axis is more than 5 degrees, it is necessary to make corrections to the velocity readings.



VIBRATION RECORD FOR RUN-IN TEST



Report No :

Project Name / Dtt Job No :

Reference Document Name / No: SITE RUN TEST PROCEDURE / EI027-DMF-VD-QC-PRO-031

Item No :

Sketch :

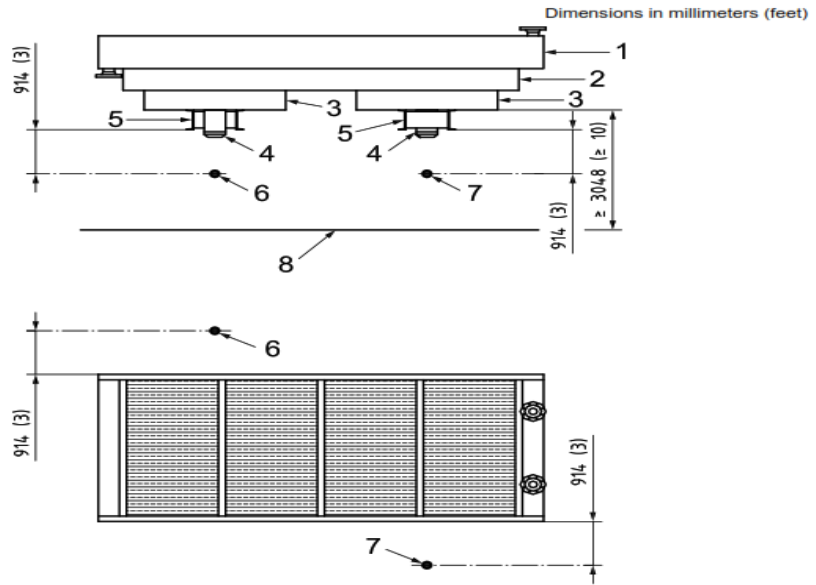

Key	
1	plenum side frame
2	plenum
3	fan ring
4	motor
5	machinery mount
6	measurement location #1
7	measurement location #2
8	ground level

Figure E.2 — L_p Measurement Locations — Forced Draught Unit (2-fan Bay)

ITEM No.			
Measure point	1	2	RPM
displacement			motor
spees(mm/s)			fan
displacement(μ m)			

DESCRIPTION:

DTT	PMC	TPA	Owner
Name :	Name :	Name :	Name :
Date :	Date :	Date :	Date :
Sign	Sign	Sign	Sign