











OWNER:  شرکت مست و سوبی توسه ایرانیاان (سهامی خاص)	BUSHEHR PETROCHEMICAL COMPANY MEG PLANT						EPC CONTRACTOR:  Chagalesh-Enerchimi-Steam Joint Venture BUPC-MEG PLANT PROJECT		
	UCP/LCP/JB GENERAL ARRANGEMENT DRAWING & TERMINAL DETAILS FOR NITROGEN GAS BOOSTER INCL. BOM						 Netherlands		
MC :  شرکت مست و سوبی توسه ایرانیاان (سهامی خاص)	Project	Area	Phase	Unit	Dis.	Doc.	Seq.	Contract No : 52-98/445	
Owner Document Number: 17811-07A	BU	20	VD	303	IN	DWG	0039	Rev.:	Page
								01	1 of 8

UCP/LCP/JB GENERAL ARRANGEMENT DRAWING & TERMINAL DETAILS FOR NITROGEN GAS BOOSTER INCL. BOM

 شرکت مست و سوبی توسه ایرانیاان (سهامی خاص)	 Chagalesh-Enerchimi-Steam Joint Venture BUPC-MEG PLANT PROJECT	BUSHEHR PETROCHEMICAL COMPANY MEG PLANT
Document Review		
Issue Purpose:	IFA	
Result Code: AP,AN,CM,RE,NC	CM	
Next Status : IFC,IFA,IFI,AFC,AB	IFA	
Responsible Department	MECHANICAL	
Commented Date	Nov/04/2021	
Approval or review hereunder shall not be construed to relieve Vendor / Subcontractor of his responsibilities and liability under the contract.		

01	19/10/2021	For approval	HT	RB	KP	
00	24/11/2020	For approval	HT	RB	KP	
Rev.	Date	Purpose of Issue	Prepared	Checked	Approved	AC Code
					Class: 1	Phase: P

OWNER:  شرکت مست و سویی گیس ایرانیان (سهامی خاص)	BUSHEHR PETROCHEMICAL COMPANY MEG PLANT						EPC CONTRACTOR:  Chagalesh-Enerchimi-Steam Joint Venture BUPC-MEG PLANT PROJECT		
	UCP/LCP/JB GENERAL ARRANGEMENT DRAWING & TERMINAL DETAILS FOR NITROGEN GAS BOOSTER INCL. BOM						 Netherlands		
MC :  شرکت مست و سویی گیس ایرانیان (سهامی خاص)	Project	Area	Phase	Unit	Dis.	Doc.	Seq.	Contract No : 52-98/445	
Owner Document Number: 17811-07A	BU	20	VD	303	IN	DWG	0039	Rev.:	Page
								01	2 of 8

TABULATION OF REVISED PAGES

Page	D00	D01	D02	D03	D04
1.	X	X			
2.	X	X			
3.	X	X			
4.	X	X			
5.	X	X			
6.	X	X			
7.	X	X			
8.	X	X			
9.	X				
10.	X				
11.	X				
12.	X				
13.	X				
14.					
15.					
16.					
17.					
18.					
19.					
20.					
21.					
22.					
23.					
24.					
25.					
26.					
27.					
28.					
29.					
30.					
31.					
32.					
33.					
34.					

Page	D00	D01	D02	D03	D04
35.					
36.					
37.					
38.					
39.					
40.					
41.					
42.					
43.					
44.					
45.					
46.					
47.					
48.					
49.					
50.					
51.					
52.					
53.					
54.					
55.					
56.					
57.					
58.					
59.					
60.					
61.					
62.					
63.					
64.					
65.					
66.					
67.					

UCP-C1002-01

- Panel lifting lugs and its details to be specified.

- GENERAL NOTES**
1. Panel material: Painted sheet steel (RAL7035)
 2. Ingress protection: IP-42
 3. Panel dimensions: 2100x800x800 mm
 4. Area classification: Safe area
 5. Drawing pocket will be included: (A3 format)

FRONT SIDE (OUTSIDE) VIEW

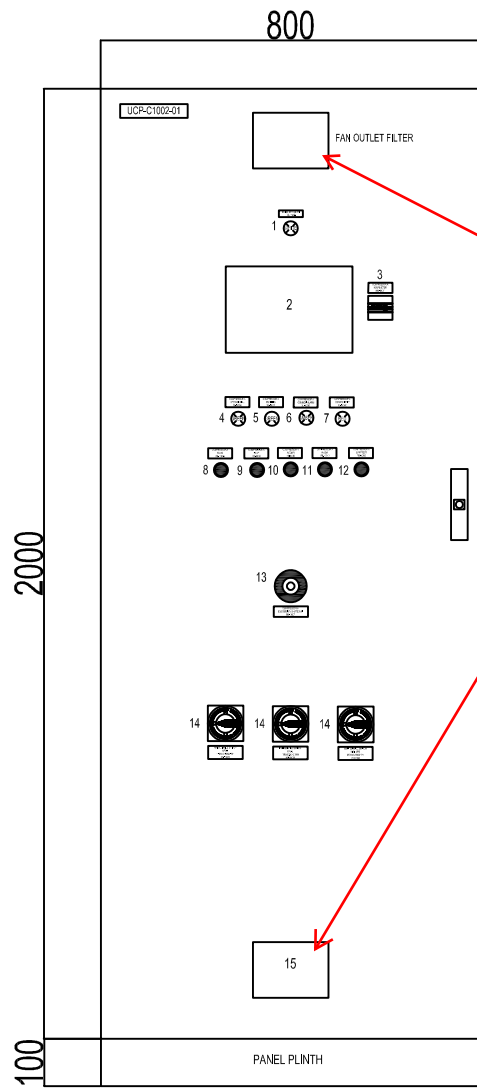

Ventilation system fitted with dust filters and with extraction fans mounted on the top of cabinets shall be provided.

FRONT SIDE (INSIDE) VIEW

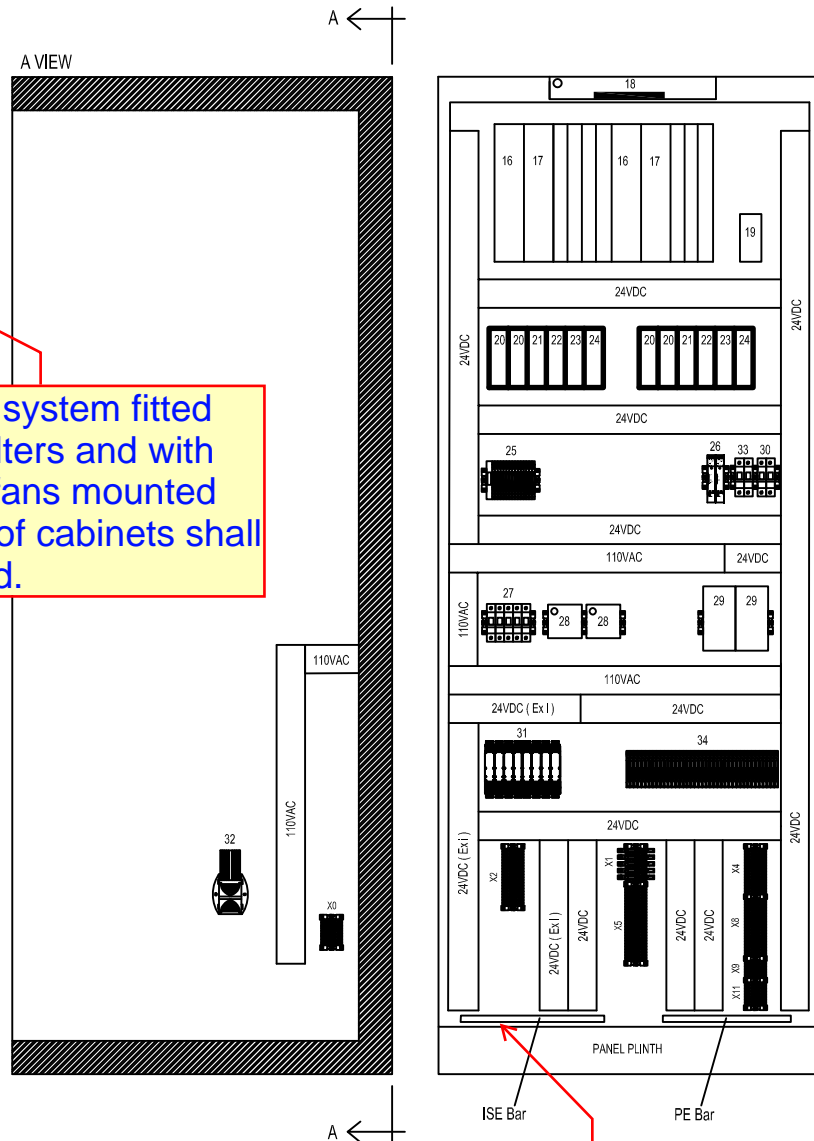

To be separate to two earth bar ISE and NISE

SIDE (OUTSIDE) VIEW

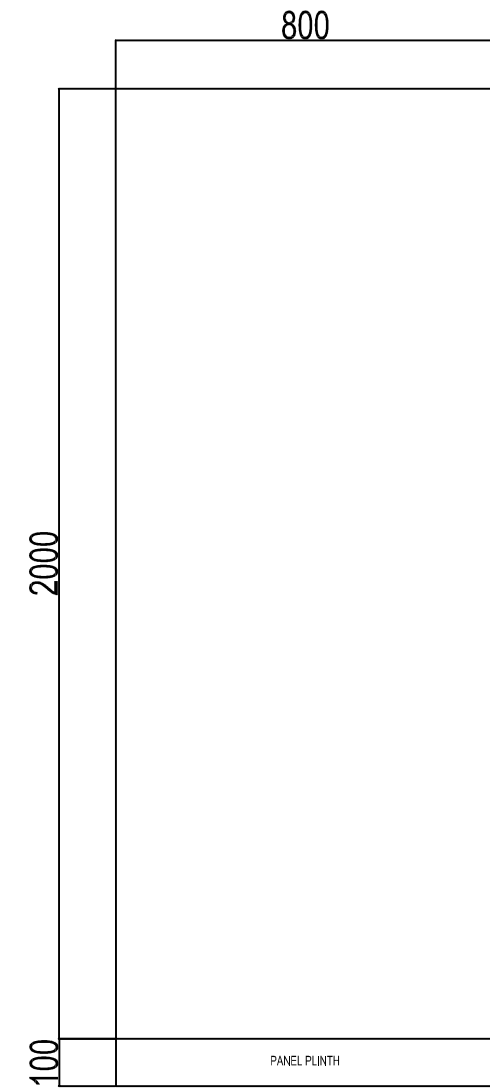

Nameplate for UCP panel

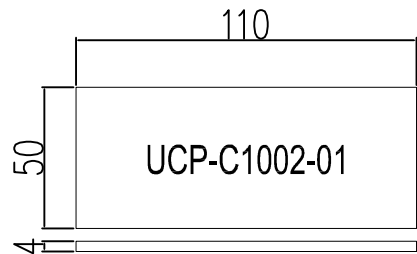

Nameplate for components on panel door (Typical)

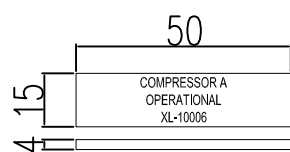

PLINTH FIXING HOLES

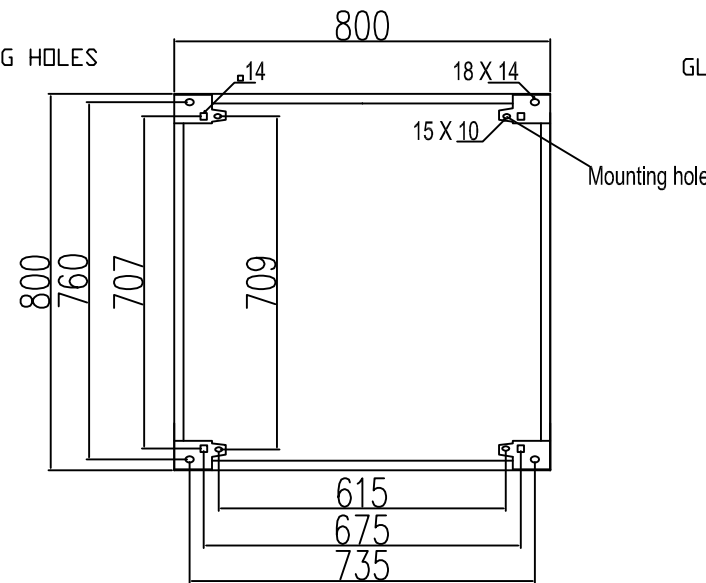

GLAND PLATE MOUNTING DETAILS

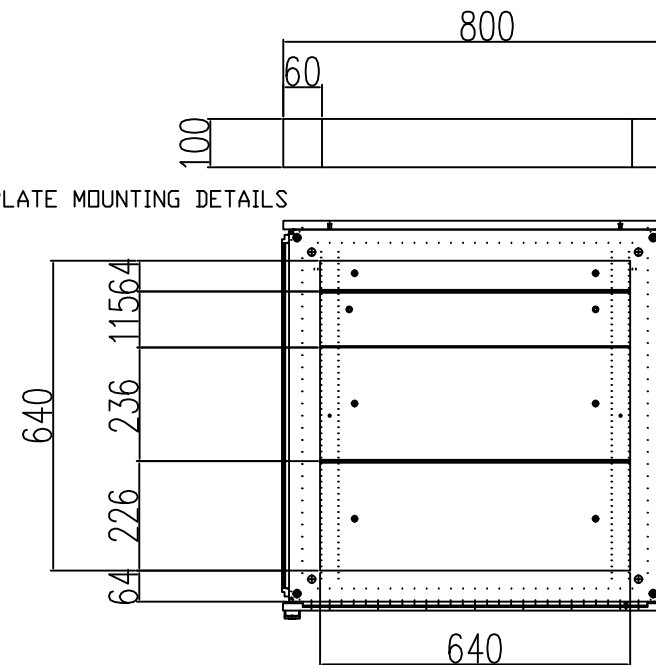

REFERENCE DRAWINGS	DWG.No.
xxxxxxx	xxxxxxx

REV.	DATE	PURPOSE OF ISSUE (P.O.I.)	PREP.	CHKD.	APPR.	AC.
01	18/10/21	For approval	HT	RB	RB	-
00	24/11/20	For approval	HT	RB	RB	-

OWNER:

MC:

CONTRACTOR:

PROJECT: BUSHEHR PETROCHEMICAL COMPANY MEG PLANT

DRAWING TITLE: 17811-07A

UCP/ICP/IB GENERAL ARRANGEMENT DRAWING & TERMINAL DETAILS FOR NITROGEN GAS

CONTRACT NO.	SCALE	SIZE	CLASS	PHASE
52-28/445	XX	A0	1	P

DOCUMENT NO.	PROJECT	AREA	PHASE	MRQ No.	DIS.	DOC.	SEQ.	SHEET	REV. NO.
00-20-10-303-0-000-0009								6	01

BU-20-VD-303-IN-DWG-0039

COPYING OR REPRODUCTION OF THIS DOCUMENT IS PROHIBITED WITHOUT THE WRITTEN PERMISSION OF BUSHEHR PETROCHEMICAL COMPANY

JNDX-C1002-01

FRONT SIDE (OUTSIDE) VIEW

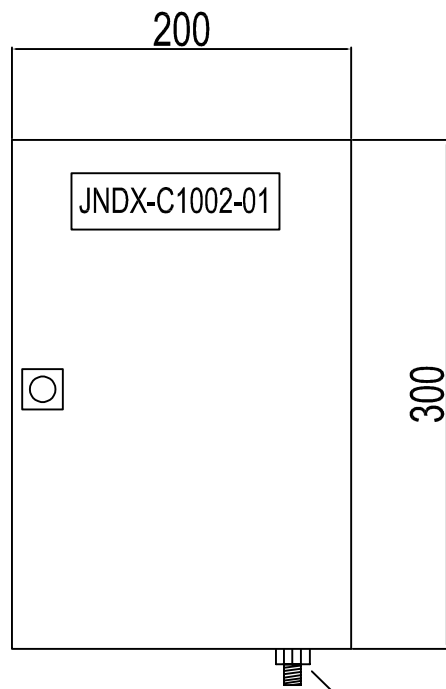

EARTHING BOSS M10

FRONT SIDE (INSIDE) VIEW

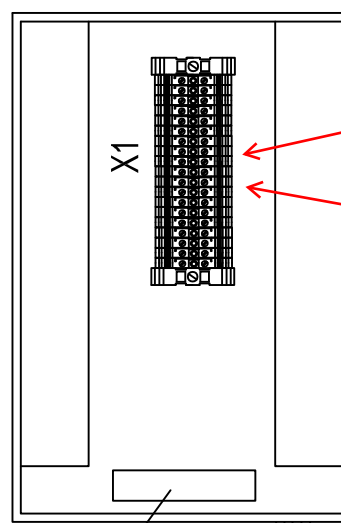

ISE Bar

EARTHING BOSS M10

SIDE (OUTSIDE) VIEW

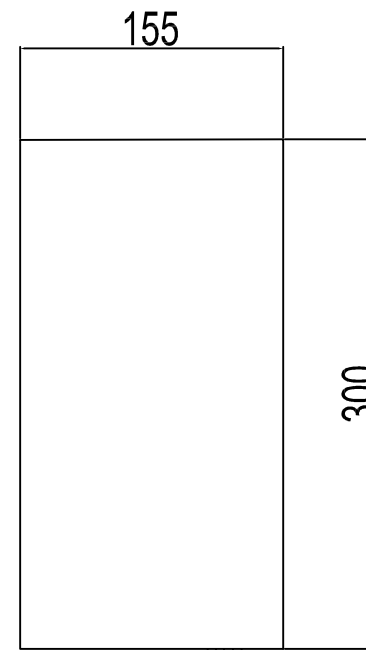

EARTHING BOSS M10

BOTTOM VIEW

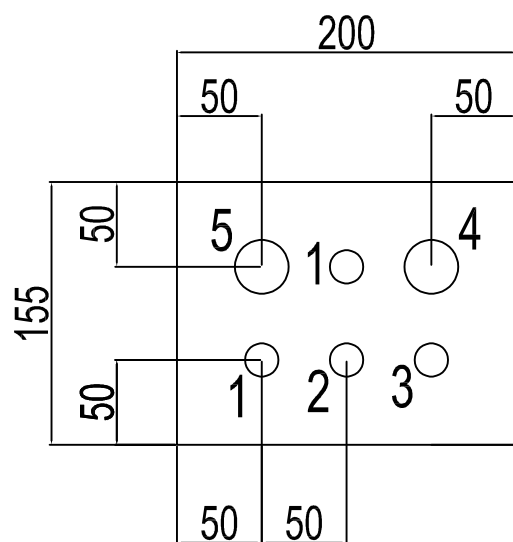

- 1 = Solenoid cable - M20
- 2 = Spare plug - M20
- 3 = Breather / Drain - M20
- 4 = Solenoid multipair cable - M32
- 5 = Spare plug - M32

For JB drawing requirement such as name plate, tag plate, terminal arrangement and etc. please refer to attached file

16 terminal

Terminal drawing detail same as attached file to be specified

(RAL 9006) Gray

- GENERAL NOTES
1. Panel material: SS316
 2. Ingress protection: IP-65
 3. Panel dimensions: 200x300x155 mm
 4. Area classification: Eex 'e' (RAL 6021) Green
 5. All spare holes are plugged with certified plugs

Refer to clause M33 of TCL Eex'd' to be considered

REFERENCE DRAWINGS	DWG.No.
xxxxxxx	xxxxxxx

GLAND ENTRY DETAILS

- M20: 1x (Breather)
- M20: 3x
- M32: 2x

Please modify to 5x

1x is sufficient

Nameplate for junction box

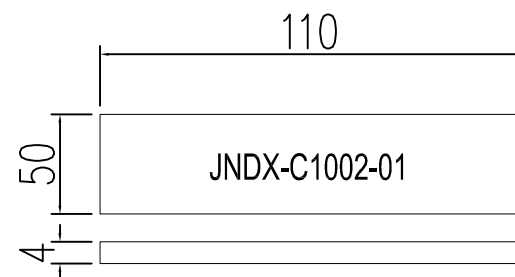

01	18/10/21	For approval	HT	RB	RB	-
00	24/11/20	For approval	HT	RB	RB	-
REV.	DATE	PURPOSE OF ISSUE (P.O.I.)	PREP.	CHKD.	APPR.	AC.
OWNER:			MC:		CONTRACTOR:	
PROJECT: BUSHEHR PETROCHEMICAL COMPANY MEG PLANT			DRAWING TITLE: 17811-07A		UCP/LCP/JB GENERAL ARRANGEMENT DRAWING & TERMINAL DETAILS FOR NITROGEN GAS	
CONTRACT NO.	SCALE	SIZE	CLASS	PHASE		
52-28/445	XX	A0	1	P		
DOCUMENT NO.	PROJECT	AREA	PHASE	MRQ No.	DIS.	DOC. SEQ.
OWNER DOC. NO.	PROJECT	AREA	PHASE	MRQ No.	DIS.	DOC. SEQ.
BU-20-VD-303-0-000-00						
						3 OF 6
						01

JIAX-C1002-01

FRONT SIDE (OUTSIDE) VIEW

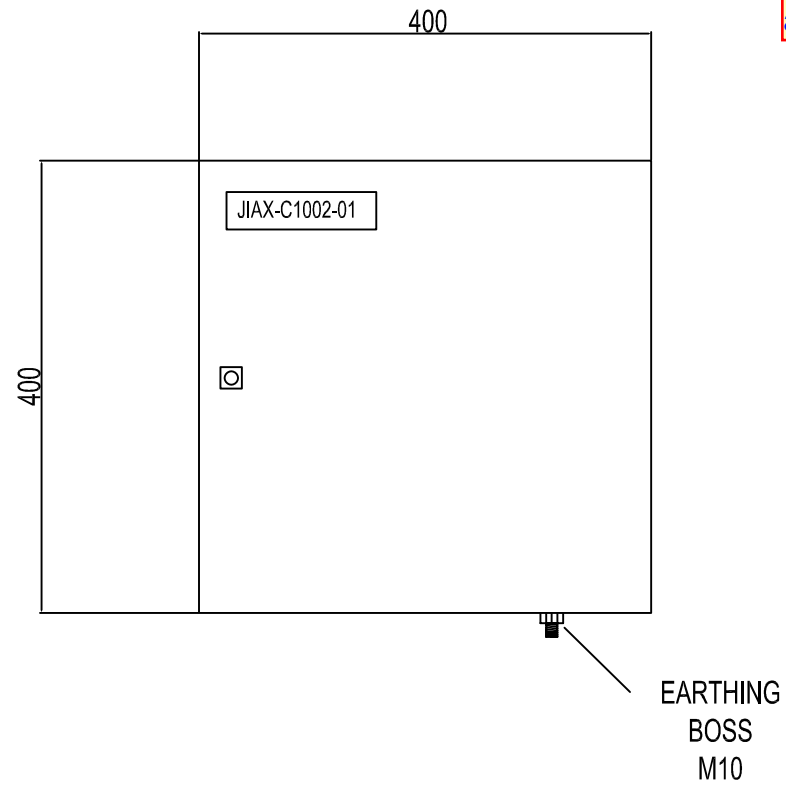

FRONT SIDE (INSIDE) VIEW

For JB drawing requirement such as name plate, tag plate, terminal arrangement and etc. please refer to attached file

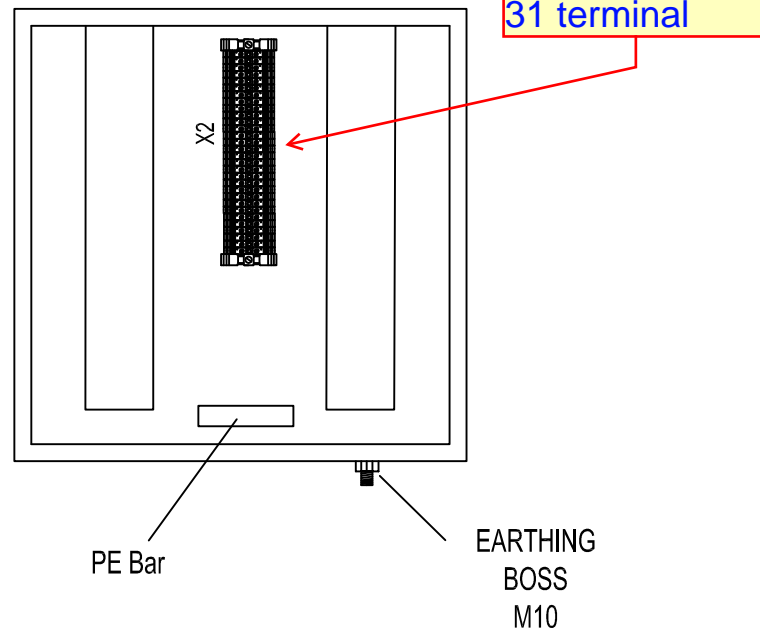

SIDE (OUTSIDE) VIEW

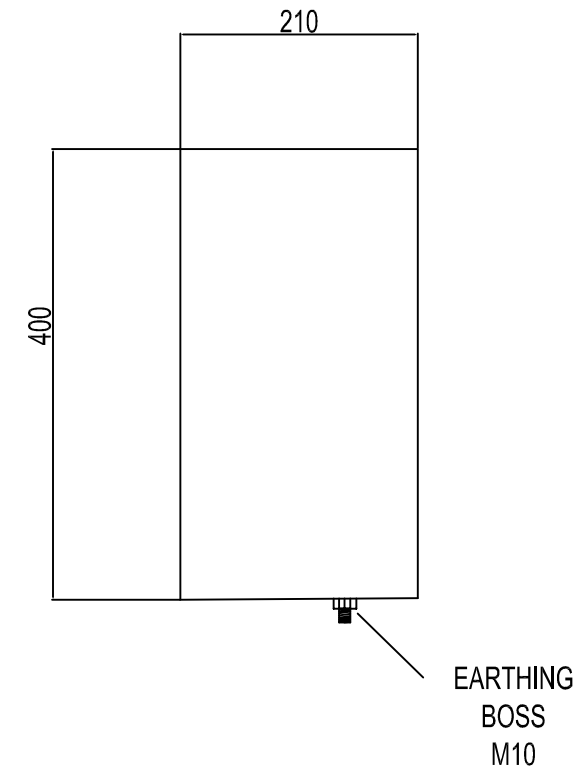

BOTTOM VIEW

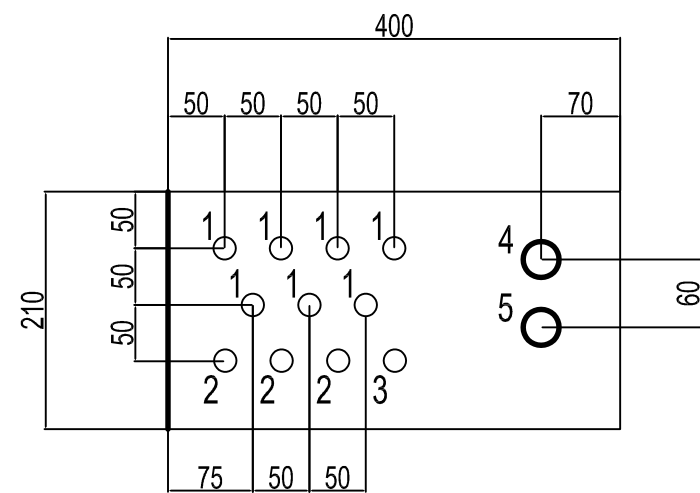

- 1 = Transmitter cable - M20
- 2 = Spare plug - M20
- 3 = Breather / Drain - M20
- 4 = Transmitter multipair cable - M32
- 5 = Spare plug - M32

GLAND ENTRY DETAILS

- M20: 1x (Breather)
 - M20: 10x
 - M32: 2x
- 1x is sufficient

Nameplate for junction box

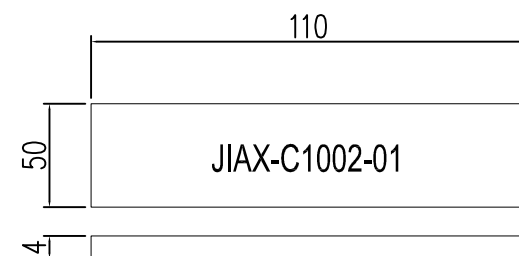

GENERAL NOTES

1. Panel material: SS316
2. Ingress protection: IP-65
3. Panel dimensions: 400x400x210 mm
4. Area classification: Eex 'i'
(RAL 5015) Blue
5. All spare holes are plugged with certified plugs

REFERENCE DRAWINGS	DWG.No.
xxxxxxx	xxxxxxx

REV.	DATE	PURPOSE OF ISSUE (P.O.I.)	PREP.	CHKD.	APPR.	AC.
01	18/10/21	For approval	HT	RB	RB	-
00	24/11/20	For approval	HT	RB	RB	-

OWNER:	MC:	CONTRACTOR:

PROJECT: BUSHEHR PETROCHEMICAL COMPANY
MEG PLANT

DRAWING TITLE: 17B11-07A
UCP/LCP/JB GENERAL ARRANGEMENT DRAWING & TERMINAL DETAILS FOR NITROGEN GAS

CONTRACT NO.	SCALE	SIZE	CLASS	PHASE
52-98/445	XX	A0	1	P

DOC. NO.	PROJECT	AREA	PHASE	MRQ No.	DIS.	DOC.	SEQ.	SHEET	REV. NO.
BU-20-10-302-0-200-000	BU-20-VD-303-IN-DWG-0039							4 OF 6	01

LP-C1002-01

FRONT SIDE (OUTSIDE) VIEW

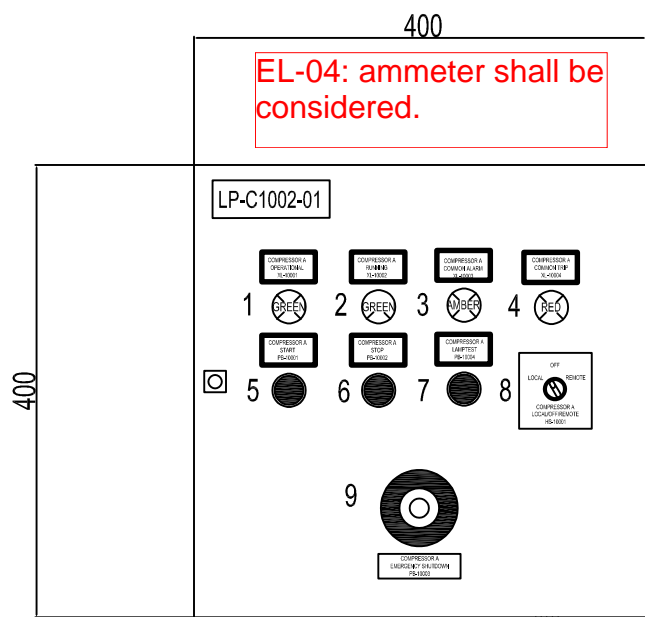

EL02:
 1- The rear of the door shall be shown with mounted devices and wiring channel.
 2-The suitable provision shall be considered for separation of 24Vdc and 230VAC in all trunking and ways.

FRONT SIDE (INSIDE) VIEW

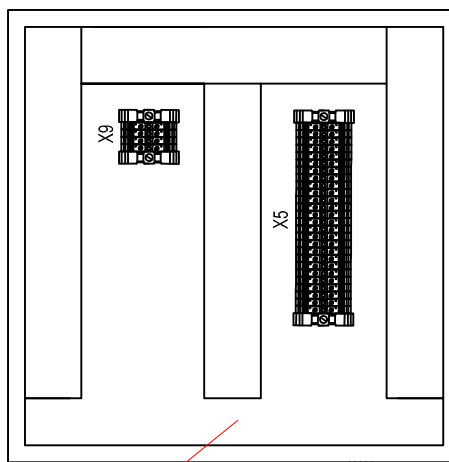

EL-03: The terminal Strip code is specified, but terminal numbers shall be add too.

SIDE (OUTSIDE) VIEW

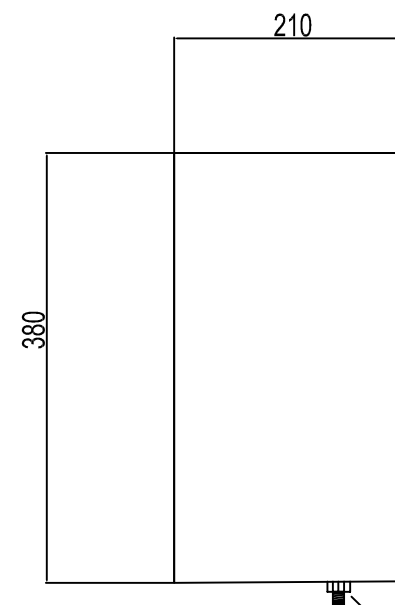

- GENERAL NOTES**
1. Panel material: SS316
 2. Ingress protection: IP-65
 3. Panel dimensions: 400x400x210 mm
 4. Area classification: Eex 'e' (RAL 6021) Green
 5. All spare holes are plugged with certified plugs

REFERENCE DRAWINGS	DWG.No.
xxxxxxx	xxxxxxx

EARTHING BOSS M10

EARTHING BOSS M10

EARTHING BOSS M10

BOTTOM VIEW

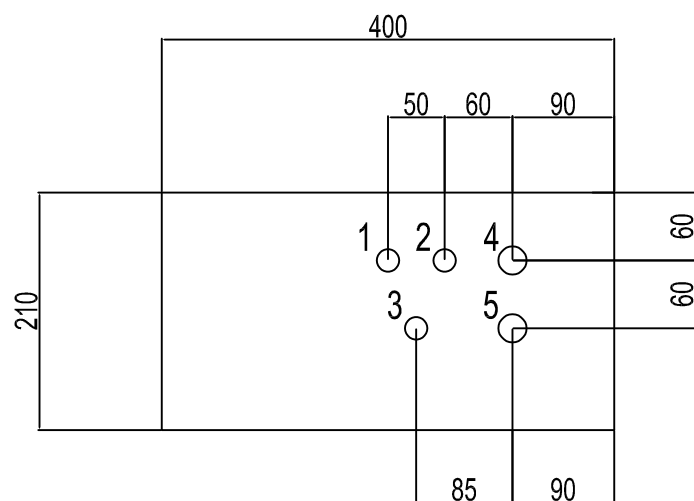

GLAND ENTRY DETAILS

- M20: 1x (Breather)
- M20: 2x
- M25: 2x

EL01:
 The technical specifications shall be completed in nameplate.
 The below items shall be added in name plate:
 -The degree of protection panel
 -The permissible withstanding short circuit current
 -The total weight of panel
 -The insulation voltage of panel
 -Manufacturer date
 -The panel tag

- 1 = ESD multicore cable - M20
- 2 = Spare plug - M20
- 3 = Breather / Drain - M20
- 4 = Pushbutton / Lamps multicore cable - M25
- 5 = Spare plug - M25

Nameplate for junction box

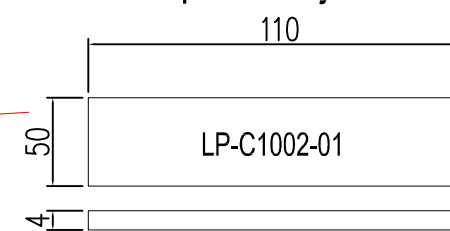

Nameplate for components on JB door (Typical)

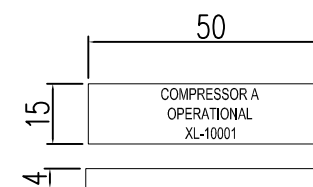

Modify the MC logo

01	18/10/21	For approval	HT	RB	RB	-		
00	24/11/20	For approval	HT	RB	RB	-		
REV	DATE	PURPOSE OF ISSUE (P.O.I)	PREP	CHKD	APPR	AC		
OWNER:		MC:	CONTRACTOR:					
PROJECT:		BUSHEHR PETROCHEMICAL COMPANY MEG PLANT						
DRAWING TITLE:		17B11-07A						
CONTRACT NO.		SCALE	SIZE	CLASS	PHASE			
52-28/445		XX	A0	1	P			
DOCUMENT NO.	PROJECT	AREA	PHASE	MRQ No.	DIS.	DOC. SEQ.	SHEET	REV. NO.
BU-20-VD-303-IN-DWG-0039	BU-20-VD-303-IN-DWG-0039						6 OF 6	01