











| | | | | | | | | | |
|---|--|------|-------|------|------|------|--|------------------------|--------|
| OWNER:  شرکت سست و سویی ژوس ایران (سهامی خاص) | BUSHEHR PETROCHEMICAL COMPANY MEG PLANT | | | | | | EPC CONTRACTOR:  Chagalesh-Enerchimi-Steam Joint Venture BUPC-MEG PLANT PROJECT | | |
| | UCP/LCP/JB GENERAL ARRANGEMENT DRAWING & TERMINAL DETAILS FOR EMERGENCY INSTRUMENT AIR COMPRESSOR INCL. BOM | | | | | |  Netherlands | | |
| MC :  شرکت سست و سویی ژوس ایران (سهامی خاص) | Project | Area | Phase | Unit | Dis. | Doc. | Seq. | Contract No: 52-98/445 | |
| Owner Document Number: 17811-07B | BU | 20 | VD | 303 | IN | DWG | 0089 | Rev.: | Page |
| | | | | | | | | 00 | 1 of 8 |

INSTRUMENT DEPARTMENT COMMENT:
Please refer to comments on BU-20-VD-303-IN-DWG-0039-01

UCP/LCP/JB GENERAL ARRANGEMENT DRAWING & TERMINAL DETAILS FOR EMERGENCY INSTRUMENT AIR COMPRESSOR INCL. BOM

| | | |
|--|---|--|
|  شرکت سست و سویی ژوس ایران (سهامی خاص) |  Chagalesh-Enerchimi-Steam Joint Venture BUPC-MEG PLANT PROJECT | BUSHEHR PETROCHEMICAL COMPANY MEG PLANT |
| Document Review | | |
| Issue Purpose: | IFA | |
| Result Code: AP,AN,CM,RE,NC | CM | |
| Next Status : IFC,IFA,IFI,AFC,AB | IFA | |
| Responsible Department | MECHANICAL | |
| Commented Date | Nov/04/2021 | |
| Approval or review hereunder shall not be construed to relieve Vendor / Subcontractor of his responsibilities and liability under the contract. | | |

| | | | | | | |
|---------------|-----------------------|-------------------------|-----------------|----------------|-----------------|----------------|
| | | | | | | |
| 01 | 19/10/2021 | For approval | HT | RB | KP | |
| 00 | 24/11/2020 | For approval | HT | RB | KP | |
| Rev. | Date | Purpose of Issue | Prepared | Checked | Approved | AC Code |
| | | | | | Class: 1 | Phase: P |

| | | | | | | | | | |
|---|--|------|-------|------|------|------|--|------------------------|--------|
| OWNER:  شرکت مست و سوبی نوسا ایرانیا (سهایی نامی) | BUSHEHR PETROCHEMICAL COMPANY MEG PLANT | | | | | | EPC CONTRACTOR  Chagalesh-Enerchimi-Steam Joint Venture BUPC-MEG PLANT PROJECT | | |
| | UCP/LCP/JB GENERAL ARRANGEMENT DRAWING & TERMINAL DETAILS FOR EMERGENCY INSTRUMENT AIR COMPRESSOR INCL. BOM | | | | | |  Netherlands | | |
| MC :  شرکت مست و سوبی نوسا ایرانیا (سهایی نامی) | Project | Area | Phase | Unit | Dis. | Doc. | Seq. | Contract No: 52-98/445 | |
| Owner Document Number: 17811-07B | BU | 20 | VD | 303 | IN | DWG | 0089 | Rev.: | Page |
| | | | | | | | | 01 | 2 of 8 |

TABULATION OF REVISED PAGES

| Page | D00 | D01 | D02 | D03 | D04 |
|------|-----|-----|-----|-----|-----|
| 1. | X | X | | | |
| 2. | X | X | | | |
| 3. | X | X | | | |
| 4. | X | X | | | |
| 5. | X | X | | | |
| 6. | X | X | | | |
| 7. | X | X | | | |
| 8. | X | X | | | |
| 9. | X | | | | |
| 10. | X | | | | |
| 11. | X | | | | |
| 12. | X | | | | |
| 13. | X | | | | |
| 14. | | | | | |
| 15. | | | | | |
| 16. | | | | | |
| 17. | | | | | |
| 18. | | | | | |
| 19. | | | | | |
| 20. | | | | | |
| 21. | | | | | |
| 22. | | | | | |
| 23. | | | | | |
| 24. | | | | | |
| 25. | | | | | |
| 26. | | | | | |
| 27. | | | | | |
| 28. | | | | | |
| 29. | | | | | |
| 30. | | | | | |
| 31. | | | | | |
| 32. | | | | | |
| 33. | | | | | |
| 34. | | | | | |

| Page | D00 | D01 | D02 | D03 | D04 |
|------|-----|-----|-----|-----|-----|
| 35. | | | | | |
| 36. | | | | | |
| 37. | | | | | |
| 38. | | | | | |
| 39. | | | | | |
| 40. | | | | | |
| 41. | | | | | |
| 42. | | | | | |
| 43. | | | | | |
| 44. | | | | | |
| 45. | | | | | |
| 46. | | | | | |
| 47. | | | | | |
| 48. | | | | | |
| 49. | | | | | |
| 50. | | | | | |
| 51. | | | | | |
| 52. | | | | | |
| 53. | | | | | |
| 54. | | | | | |
| 55. | | | | | |
| 56. | | | | | |
| 57. | | | | | |
| 58. | | | | | |
| 59. | | | | | |
| 60. | | | | | |
| 61. | | | | | |
| 62. | | | | | |
| 63. | | | | | |
| 64. | | | | | |
| 65. | | | | | |
| 66. | | | | | |
| 67. | | | | | |

JNDX-C7080-01

FRONT SIDE (OUTSIDE) VIEW

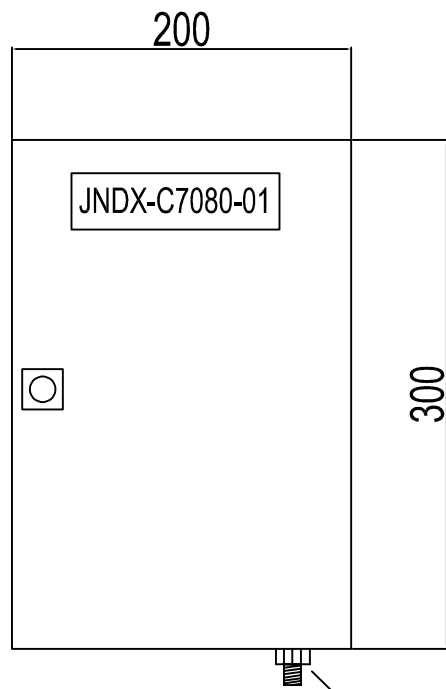

EARTHING
BOSS
M10

FRONT SIDE (INSIDE) VIEW

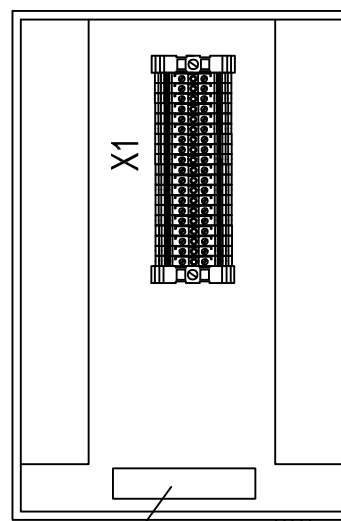

ISE Bar

EARTHING
BOSS
M10

SIDE (OUTSIDE) VIEW

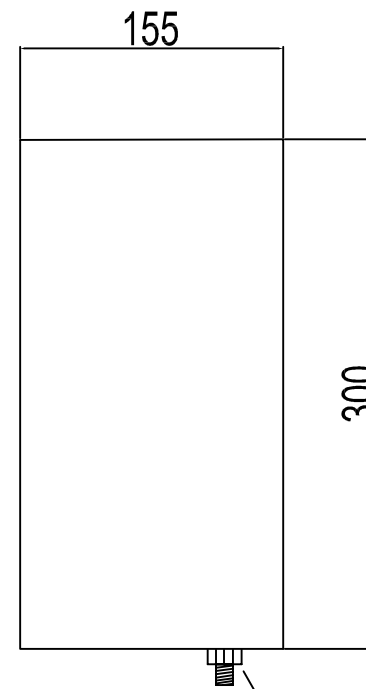

EARTHING
BOSS
M10

BOTTOM VIEW

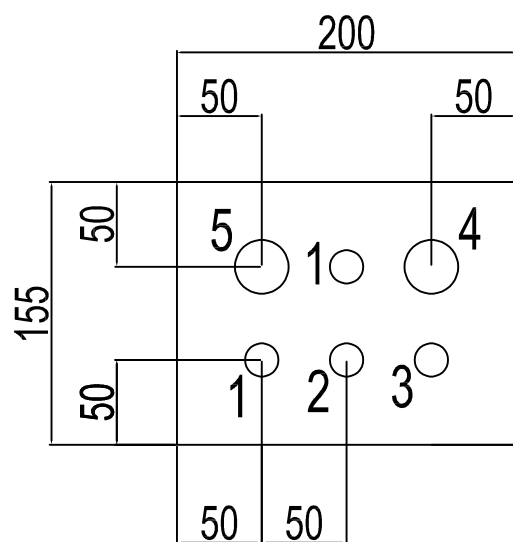

- 1 = Solenoid cable - M20
- 2 = Spare plug - M20
- 3 = Breather / Drain - M20
- 4 = Solenoid multipair cable - M32
- 5 = Spare plug - M32

GLAND ENTRY DETAILS

- M20: 1x (Breather)
- M20: 3x
- M32: 2x

Nameplate for junction box

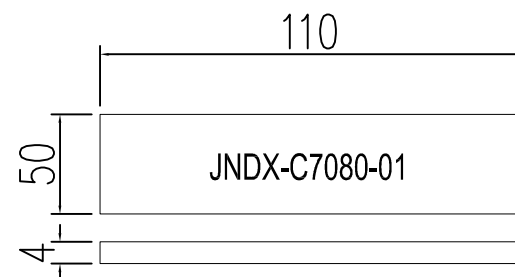

Modify the MC logo

GENERAL NOTES

1. Panel material: SS316
2. Ingress protection: IP-65
3. Panel dimensions: 200x300x155 mm
4. Area classification: Eex 'e' (RAL 6021) Green
5. All spare holes are plugged with certified plugs

REFERENCE DRAWINGS

xxxxxxx

DWG.No.

xxxxxxx

| REV | DATE | PURPOSE OF ISSUE (P.O.I) | PREP | CHKD | APPR | AC |
|-----|----------|--------------------------|------|------|------|----|
| 01 | 19/10/21 | For approval | HT | RB | RB | - |
| 00 | 24/11/20 | For approval | HT | RB | RB | - |

| | | |
|--------|-----|-------------|
| OWNER: | MC: | CONTRACTOR: |
| | | |

PROJECT: BUSHEHR PETROCHEMICAL COMPANY
MEG PLANT

DRAWING TITLE: 17811-07B

CONTRACT NO. 52-88/445
SCALE XX
SIZE A0
CLASS 1
PHASE P

| DOCUMENT NO. | PROJECT | AREA | PHASE | MRQ No. | DIS. | DOC. | SEQ. | SHEET | REV. NO. |
|---------------------|---------|------|-------|---------|------|------|------|--------|----------|
| BU-20-VD-303-IN-008 | | | | | | | | 3 OF 6 | 00 |

OWNER DOC. NO.: BU-20-VD-303-IN-DWG-0089

JIAX-C7080-01

FRONT SIDE (OUTSIDE) VIEW

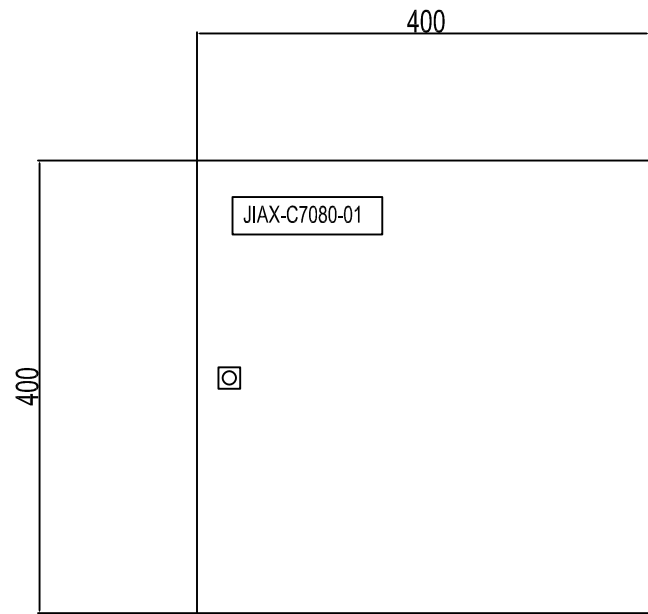

EARTHING BOSS M10

FRONT SIDE (INSIDE) VIEW

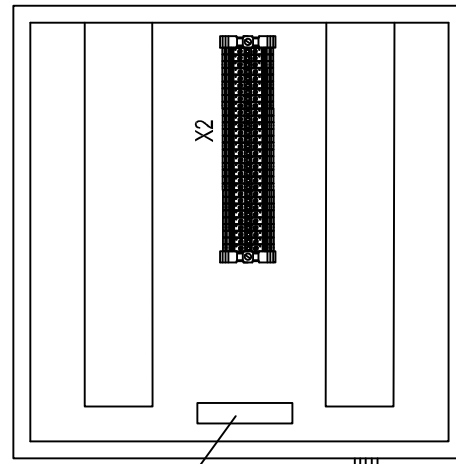

PE Bar

EARTHING BOSS M10

SIDE (OUTSIDE) VIEW

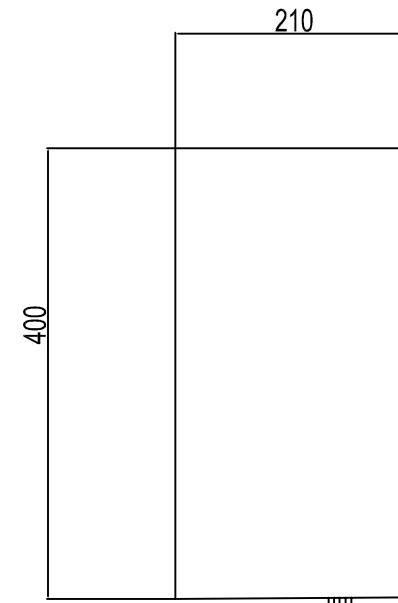

EARTHING BOSS M10

BOTTOM VIEW

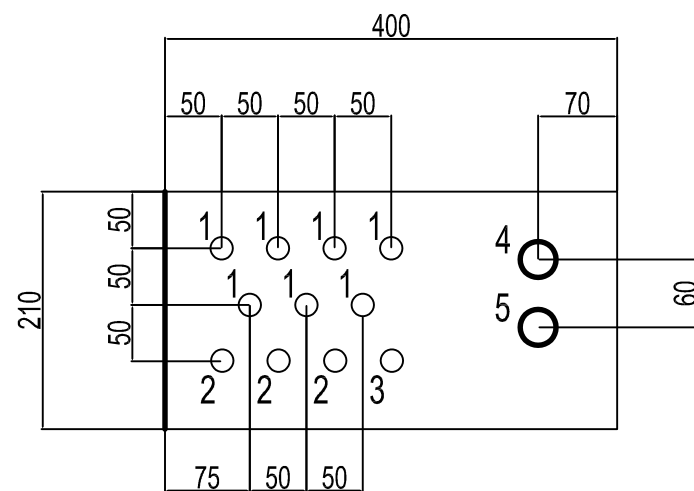

- 1 = Transmitter cable - M20
- 2 = Spare plug - M20
- 3 = Breather / Drain - M20
- 4 = Transmitter multipair cable - M32
- 5 = Spare plug - M32

GLAND ENTRY DETAILS

- M20: 1x (Breather)
- M20: 10x
- M32: 2x

Nameplate for junction box

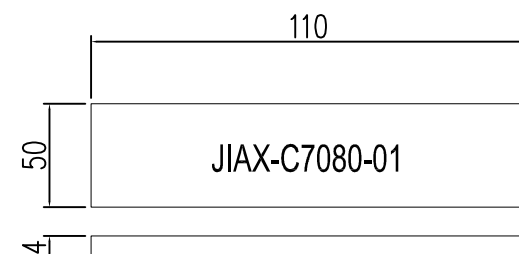

Modify the MC logo

GENERAL NOTES

1. Panel material: SS316
2. Ingress protection: IP-65
3. Panel dimensions: 400x400x210 mm
4. Area classification: Eex 'I' (RAL 5015) Blue
5. All spare holes are plugged with certified plugs

| REFERENCE DRAWINGS | DWG.No. |
|--------------------|---------|
| xxxxxxx | xxxxxxx |

| REV. | DATE | PURPOSE OF ISSUE (P.O.I) | PREP. | CHKD. | APPR. | AC. |
|------|----------|--------------------------|-------|-------|-------|-----|
| 01 | 19/10/21 | For approval | HT | RB | RB | - |
| 00 | 24/11/20 | For approval | HT | RB | RB | - |

| | | |
|--------|-----|-------------|
| OWNER: | MC: | CONTRACTOR: |
| | | |

| | |
|-------------------------------------|---|
| PROJECT: | BUSHEHR PETROCHEMICAL COMPANY MEG PLANT |
| DRAWING TITLE: | 17B11-07B |
| CONTRACT NO. SCALE SIZE CLASS PHASE | |
| 52-98/445 | XX A0 1 P |
| DOCUMENT NO. | PROJECT AREA PHASE MRQ No. DIS. DOC. SEQ. SHEET |
| BU-20-10-303-0-000-0089 | BU-20-VD-303-IN-DWG-0089 4 OF 6 |

