







OWNER:  شرکت سست و سویی توهمه ایران (سایه و شیشه)	BUSHEHR PETROCHEMICAL COMPANY MEG PLANT						EPC CONTRACTOR:  Chagalesh-Enerchimi-Steam Joint Venture BUPC-MEG PLANT PROJECT		
	ARCHITECTURE DIAGRAM FOR NITROGEN GAS BOOSTER								
MC :  شرکت سست و سویی توهمه ایران (سایه و شیشه)	Project	Area	Phase	Unit	Dis.	Doc.	Seq.	Contract No : 52-98/445	
Owner Document Number: 17811-46A	BU	20	VD	303	IN	DIG	0044	Rev.:	Page
								03	1 of 3

ARCHITECTURE DIAGRAM FOR NITROGEN GAS BOOSTER

 شرکت پترو شیمی بوشر	 Chagalesh-Enerchimi-Steam Joint Venture BUPC-MEG PLANT PROJECT	BUSHEHR PETROCHEMICAL COMPANY MEG PLANT
Document Review		
Issue Purpose:	AFC	
Result Code: AP,AN,CM,RE,NC	AP	
Next Status : IFC,IFA,IFI,AFC,AB	-	
Responsible Department	MECHANICAL	
Commented Date	7/13/2022	
Approval or review hereunder shall not be construed to relieve Vendor / Subcontractor of his responsibilities and liability under the contract.		

03	05/07/2022	Approved for Construction	KP	CL	JR	
02	09/06/2022	For Approval	KP	CL	JR	
01	10/05/2022	For Approval	KP	CL	JR	
00	12/03/2021	For Approval	TJ	KP	JR	
Rev.	Date	Purpose of Issue	Prepared	Checked	Approved	AC Code
					Class: 1	Phase: P

Abbreviations:
 FCS : Field Control System
 ESD : Emergency Shutdown
 EWS : Engineering Work Station
 OWS : Operating Work Station
 HMI : Human Machine Interface
 MSP : Motor Starter Panel

Notes:
 1. One common laptop for Nitrogen and air compressor

Serial
 Hardwired

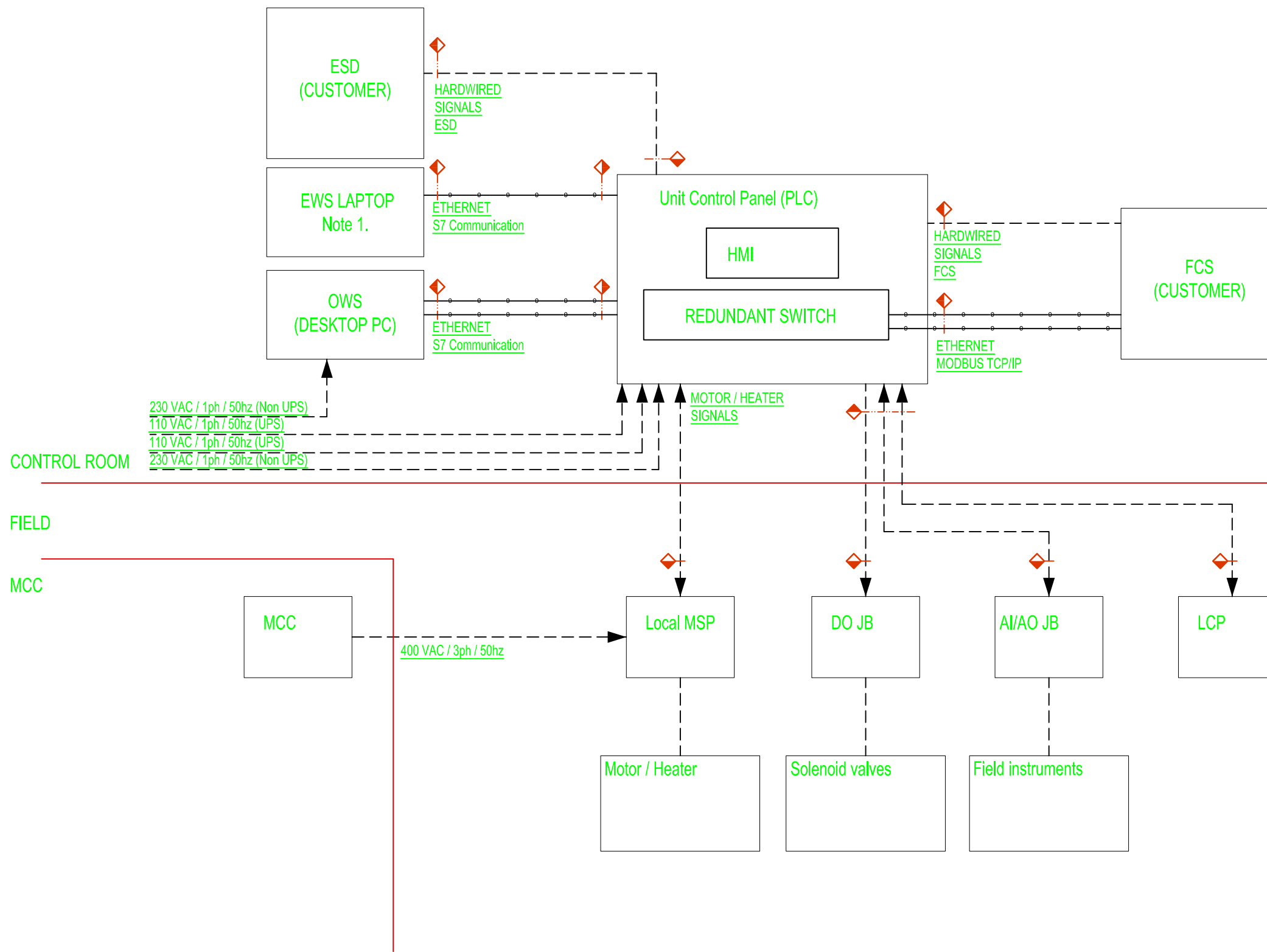

NOTES:



SUBJECT	MEG PLANT NITROGEN COMPRESSOR PLC ARCHITECTURE DIAGRAM	DATE	11-03-2021
CLIENT	BUSHEHER PETROCHEMICAL COMPANY (BUPC)	DRAWN BY	TJ
CLIENT REF	MEG20-PO-BP303-021	CHECKED BY	KP
AIRPACK REF	17811-COM	PLANT LOCATION	-
		DRAWING NO.	17811-46A
		SHEETNO.	01 /01

THIS DRAWING IS OWNED BY AIRPACK AND SHALL NOT BE PRINTED OR COPIED IN ANY OTHER WAY THAN WITH AIRPACKS PERMISSION			
REV 03	05-07-2022	KP	
REV 02	08-06-2022	KP	
REV 01	10-05-2022	KP	
REV 00	11-03-2021	TJ	