











OWNER:  شرکت ست و پتروشیمی ایران (سهامی خاص)	BUSHEHR PETROCHEMICAL COMPANY MEG PLANT						EPC CONTRACTOR:  Chagalesh-Enerchimi-Steam Joint Venture BUPC-MEG PLANT PROJECT		
	UCP/LCP/JB GENERAL ARRANGEMENT DRAWING & TERMINAL DETAILS FOR EMERGENCY INSTRUMENT AIR COMPRESSOR INCL. BOM						 Netherlands		
MC :  شرکت ست و پتروشیمی ایران (سهامی خاص)	Project	Area	Phase	Unit	Dis.	Doc.	Seq.	Contract No: 52-98/445	
Owner Document Number: 17811-07B	BU	20	VD	303	IN	DWG	0089	Rev.:	Page
								03	1 of 8

UCP/LCP/JB GENERAL ARRANGEMENT DRAWING & TERMINAL DETAILS FOR EMERGENCY INSTRUMENT AIR COMPRESSOR INCL. BOM

 شرکت ست و پتروشیمی ایران (سهامی خاص)	 Chagalesh-Enerchimi-Steam Joint Venture BUPC-MEG PLANT PROJECT	BUSHEHR PETROCHEMICAL COMPANY MEG PLANT
Document Review		
Issue Purpose:	IFA	
Result Code: AP,AN,CM,RE,NC	CM	
Next Status : IFC,IFA,IFI,AFC,AB	IFA	
Responsible Department	MECHANICAL	
Commented Date	Sep/10/2022	
Approval or review hereunder shall not be construed to relieve Vendor / Subcontractor of his responsibilities and liability under the contract.		

Rev.	Date	Purpose of Issue	Prepared	Checked	Approved	AC Code
03	08/08/2022	For approval	BK	RB	KP	
03	16/06/2022	For approval	BK	RB	KP	
02	14/12/2021	For approval	HT	RB	KP	
01	19/10/2021	For approval	HT	RB	KP	
00	24/11/2020	For approval	HT	RB	KP	
		Class: 1		Phase: P		

OWNER:  شرکت ست دوی توسه ایرانیان (سامی تاس)	BUSHEHR PETROCHEMICAL COMPANY MEG PLANT						EPC CONTRACTOR  Chagalesh-Enerchimi-Steam Joint Venture BUPC-MEG PLANT PROJECT		
	UCP/LCP/JB GENERAL ARRANGEMENT DRAWING & TERMINAL DETAILS FOR EMERGENCY INSTRUMENT AIR COMPRESSOR INCL. BOM						 Netherlands		
MC :  شرکت ست دوی توسه ایرانیان (سامی تاس)	Project	Area	Phase	Unit	Dis.	Doc.	Seq.	Contract No: 52-98/445	
Owner Document Number: 17811-07B	BU	20	VD	303	IN	DWG	0089	Rev.:	Page
								03	2 of 8

TABULATION OF REVISED PAGES

Page	D00	D01	D02	D03	D04
1.	X	X	X	X	X
2.	X	X	X	X	X
3.	X	X	X	X	X
4.	X	X	X	X	X
5.	X	X	X	X	X
6.	X	X	X	X	X
7.	X	X	X	X	X
8.	X	X	X	X	X
9.	X				
10.	X				
11.	X				
12.	X				
13.	X				
14.					
15.					
16.					
17.					
18.					
19.					
20.					
21.					
22.					
23.					
24.					
25.					
26.					
27.					
28.					
29.					
30.					
31.					
32.					
33.					
34.					

Page	D00	D01	D02	D03	D04
35.					
36.					
37.					
38.					
39.					
40.					
41.					
42.					
43.					
44.					
45.					
46.					
47.					
48.					
49.					
50.					
51.					
52.					
53.					
54.					
55.					
56.					
57.					
58.					
59.					
60.					
61.					
62.					
63.					
64.					
65.					
66.					
67.					



Nr	Description	Tagnumber	Make	Qty	Modelnumbers
1.	Panel power on lamp (white)	2H19	Schneider	1	XB4BVB1
2.	Display	8A9	Siemens	1	6AV2124-0GC01-0AX0
3.	Hourmeter	25U12	Bauser	1	629.1
4.	Operational lamp (green)	25H4	Schneider	1	XB4BVB3
5.	Running lamp (green)	25H6	Schneider	1	XB4BVB3
6.	Common alarm lamp (amber)	25H8	Schneider	1	XB4BVB5
7.	Common trip lamp (red)	25H10	Schneider	1	XB4BVB4
8.	Start pushbutton (green)	11S4	Schneider	1	XB4BA31
9.	Stop pushbutton (red)	11S6	Schneider	1	XB4BA42
10.	Accept pushbutton (black)	11S10	Schneider	1	XB4BA21
11.	Reset pushbutton (black)	11S12	Schneider	1	XB4BA21
12.	Lamp test pushbutton (black)	11S8	Schneider	1	XB4BA21
13.	ESD button	3S6	Schneider	1	(XB4BS8444 + ZBZ1605)
14.	Maintenance switch	2S2, 2S4, 2S6	Schneider	3	VBF01
15.	Panel fan + outlet filter	2M14	Rittal	1	SK3239.124
16.	PLC power supply	5M2, 5M11	Siemens	2	6ES7405-0KR02-0AA0
17.	CPU	5M3, 5M12	Siemens	2	6ES7414-5HM06-0AB0
18.	CP443-1 Communication module	5M5, 5M14	Siemens	2	6GK7443-1EX30-0XE0
19.	Panel light	2H10	Rittal	1	SZ25000.209/400/470
20.	Ethernet switch	5M18	Siemens	1	6GK7277-1AA10-0AA0
21.	IM153-2 HF Profibus DP module	6M2, 6M4, 7M1, 7M3	Siemens	4	6ES7153-2BA10-0XBA
22.	24 Digital input module	6M7, 6M9, 7M7, 7M9	Siemens	4	6ES7326-1BK02-0AB0
23.	6 Analog input module	6M10, 6M12, 6M14, 7M10, 7M12, 7M14	Siemens	6	6ES7336-4GE00-0AB0
24.	10 Digital output module	6M15, 6M16, 6M18, 6M19, 7M15, 7M16, 7M18, 7M19	Siemens	8	6ES7326-2BF10-0AB0
25.	Interface relay	24K4/6, 27K8, 28K3/5/8/10, 30K4/6/10, 56K4/6/8/10/13/15/17, 57K8/10/12, 58K9/12/13/17	Phoenix contact	24	2966171
26.	ESD relay	3ESDR8, 3ESDR8	Pilz	2	2967060
27.	Miniature circuit breaker 1P+N 110VAC / 230VAC	2F9, 2F11, 2F15, 2F17	Schneider	4	A9P54 (606/ 602/ 610/ 610)
28.	Thermostat	2TH11, 2TH14	Rittal	2	SK3110000
29.	Panel power supply	2V15, 2V17	Phoenix contact	2	2866778
30.	Miniature circuit breaker 1P	215.1, 2F17.1	Schneider	2	A6N61512
31.	Loop splitter	9U4/5/6/6.1/7/8/9/10/11/12	Pepperl+Fuchs	17	KFD2-5TL5-EX1.20
32.	Panel heater	2U13	Rittal	1	SZ2506.120
33.	Miniature circuit breaker 1P+N 24VDC	5F2, 5F11	Schneider	2	A9N61526
34.	Diode	9V4, 9V4.1, 24V4/6, 25V4/6/8/10/12, 26V4/6/8/10/12, 27V4/6/8, 28V4/6/8/10/12, 30V4/6/10 47V4/6, 48V4/6/8/10/12, 49V4/6/8/10/12, 50V4/6/8, 51V4/6/8/10/12, 53V4/6/10	Phoenix contact	48	3064137
35.	PID controller	34U2	Pepperl+Fuchs	1	(E5CC-CX3D5M-0050I+492F-52)
36.	Quint diode	2G15	Phoenix contact	1	2907719

GENERAL NOTES
1. Tag numbers correspond with electrical diagram
2. All the parts that are on the list in the panel layout will be included in the IOM.

REFERENCE DRAWINGS	DWG.No.
xxxxxxx	xxxxxxx

Nr	Description	Tagnumber	Make	Qty	Modelnumbers
X0	Terminal strip	X0...	Weidmuller	9	WBU4
X1	Terminal strip	X1...	Weidmuller	10	WBU4
X2	Terminal strip	X2...	Weidmuller	40	WBU4
X3	Terminal strip	X3...	Weidmuller	8	WBU4
X4	Terminal strip	X4...	Weidmuller	16	WBU4
X5	Terminal strip	X5...	Weidmuller	26	WBU4
X8	Terminal strip	X8...	Weidmuller	20	WBU4
X9	Terminal strip	X9...	Weidmuller	9	WBU4
X10	Terminal strip	X10...	Weidmuller	4	WBU4
X11	Terminal strip	X11...	Weidmuller	4	WBU4

REV.	DATE	PURPOSE OF ISSUE (P.O.I.)	PREP.	CHKD.	APPR.	AC.
03	04/08/22	For approval	BK	RB	RB	-
02	14/12/21	For approval	BK	RB	RB	-
01	19/10/21	For approval	HT	RB	RB	-
00	24/11/20	For approval	HT	RB	RB	-

OWNER:  MC:  CONTRACTOR: 

PROJECT: BUSHEHR PETROCHEMICAL COMPANY
MEG PLANT

DRAWING TITLE: 17811-07B
TOP/LOP/0 GENERAL ARRANGEMENT DRAWING & TERMINAL DETAILS FOR EMERGENCY INSTRUMENT AIR COMPRESSOR

CONTRACT NO.	SCALE	SIZE	CLASS	PHASE
52-98/445	XX	A0	1	P

DOCUMENT NO.	PROJECT	AREA	PHASE	MIRQ No.	DIS.	DOC.	SEQ.	SHEET	REV. NO.
BU-20-30-30-000-000	BU-20-VD	303-IN	DWG	0089	1	OF	6	03	

UCP-C7080-01

EL:
 This document shall match "UCP/LCP/JB WIRING DIAGRAM FOR EMERGENCY INSTRUMENT AIR COMPRESSOR" document.
 All changes in "wiring diagram" document shall be added here.
 Such as Signal Lamp, Push Button and

Moreover, Tag number for equipment shall match "wiring diagram" document.

This note is not accepted and must be deleted. document must be revised based on final data.

- GENERAL NOTES
1. Panel material: Painted sheet steel (RAL7035)
 2. Ingress protection: IP-42
 3. Panel dimensions: 2100x800x800 mm
 4. Area classification: Safe area
 5. Drawing pocket will be included: (A3 format)
 6. The model numbers are not official yet, it depends on what the market does. It is possible that it will still change over time.

EL:
 Name and Document Numbers shall be added.

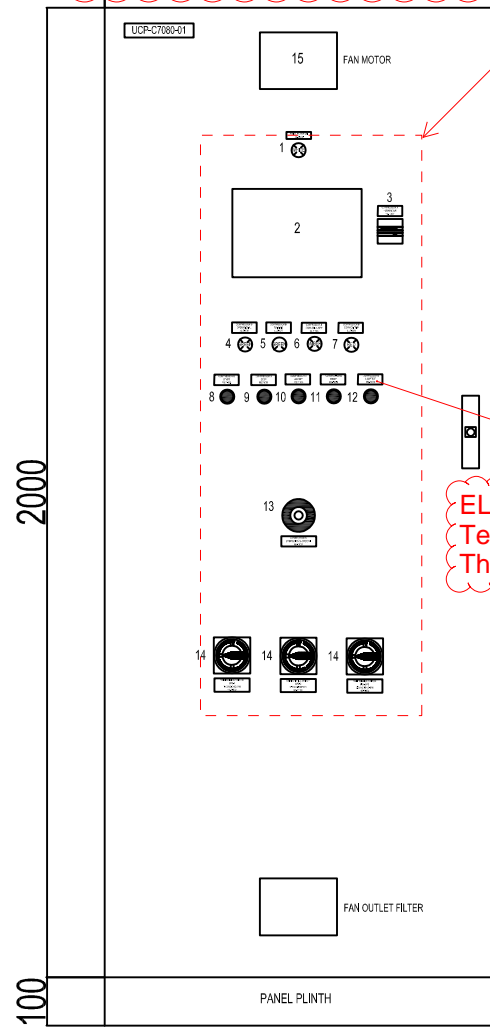

EL:
 Texts are not readable.
 The quality is very low.

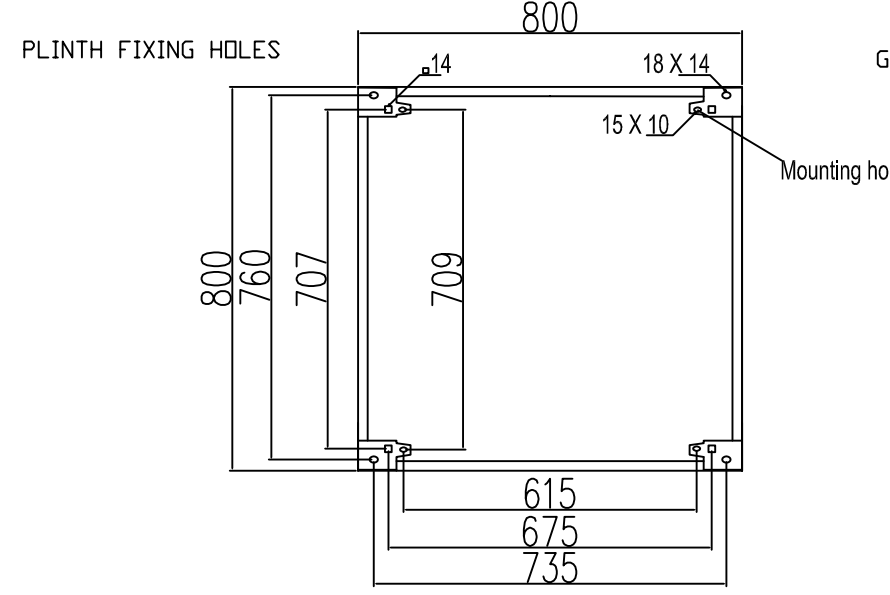
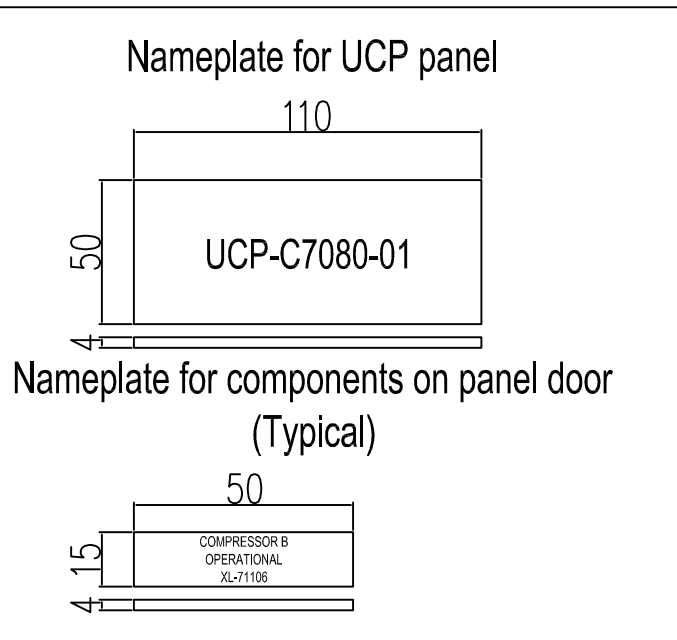
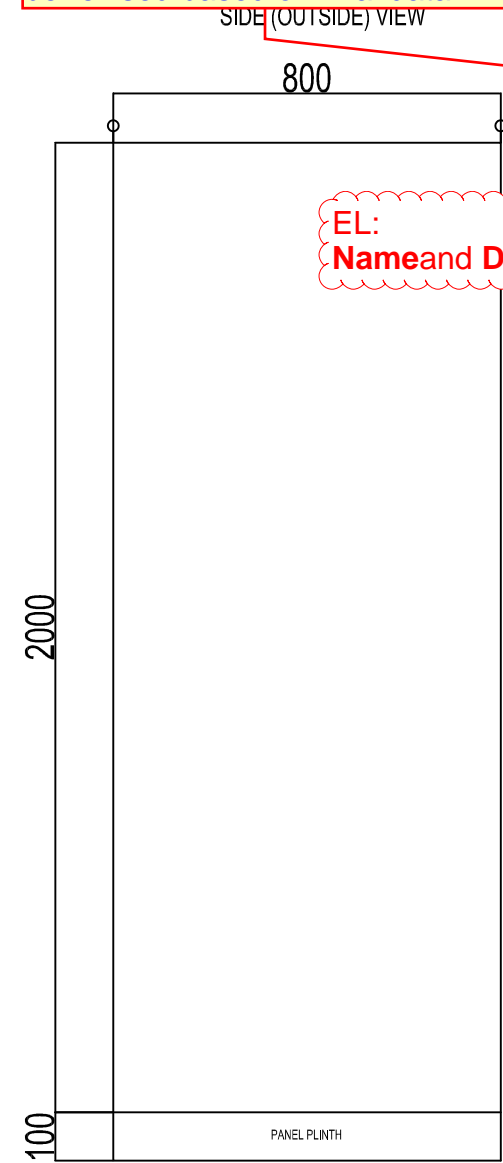
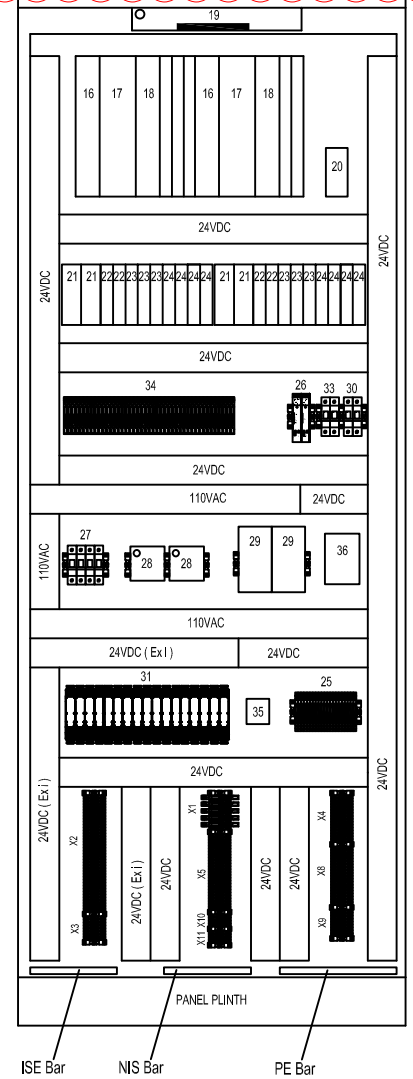
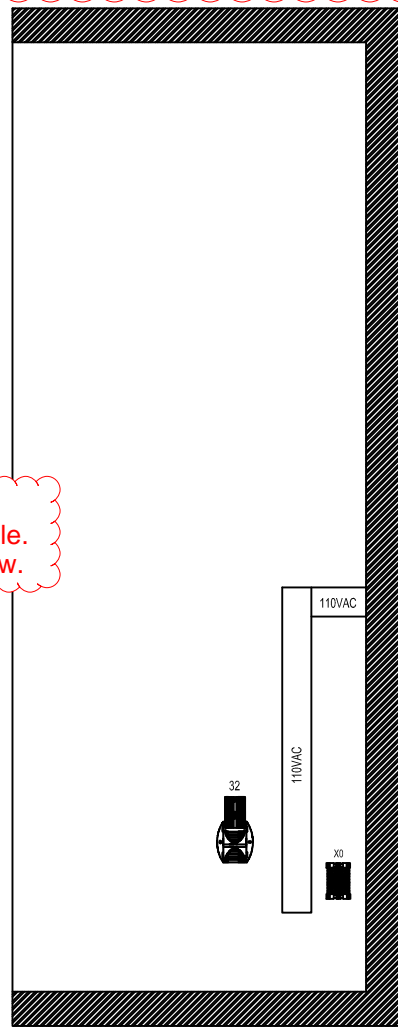

REFERENCE DRAWNGS	DWG.No.
xxxxxxx	xxxxxxx

REV.	DATE	PURPOSE OF ISSUE (P.O.I.)	PREP.	CHKD.	APPR.	AC.
03	04/06/22	For approval	BK	RB	RB	-
02	14/06/20	For approval	BK	RB	RB	-
02	14/12/21	For approval	HT	RB	RB	-
01	18/10/21	For approval	HT	RB	RB	-
00	24/11/20	For approval	HT	RB	RB	-

OWNER:

CONTRACTOR:

PROJECT: BUSHEHR PETROCHEMICAL COMPANY MEG PLANT

DRAWING TITLE: 17811-07B
 UCP/LCP/JB GENERAL ARRANGMENT DRAWING & TERMINAL DETAILS FOR EMERGENCY INSTRUMENT AIR COMPRESSOR

CONTRACT NO.	SCALE	SIZE	CLASS	PHASE
52-98/445	XX	A0	1	P

DOCUMENT NO.	PROJECT	AREA	PHASE	MIRG No.	DIS.	DOC.	SEQ.	SHEET	REV. NO.
BU-20-VD-303-IN-DWG-0089	BU-20-VD-303-IN-DWG-0089							2 OF 6	03

JNDX-C7080-01

FRONT SIDE (OUTSIDE) VIEW

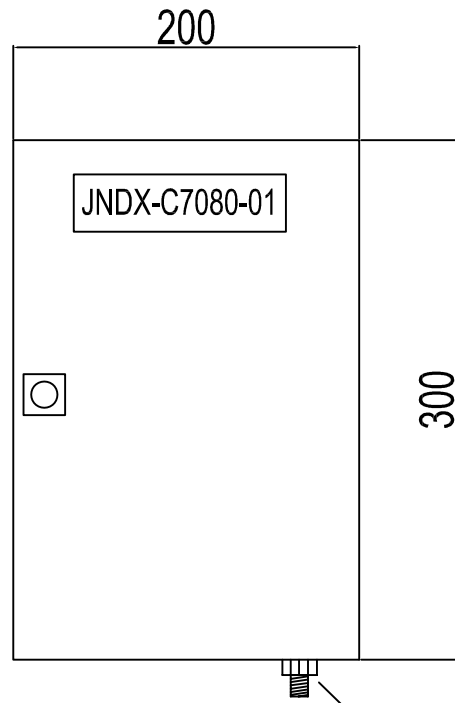

EARTHING BOSS M10

FRONT SIDE (INSIDE) VIEW

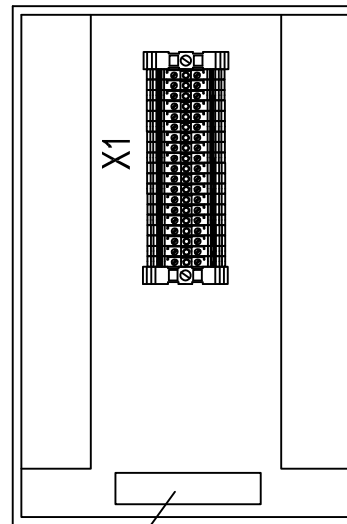

PE Bar

EARTHING BOSS M10

SIDE (OUTSIDE) VIEW

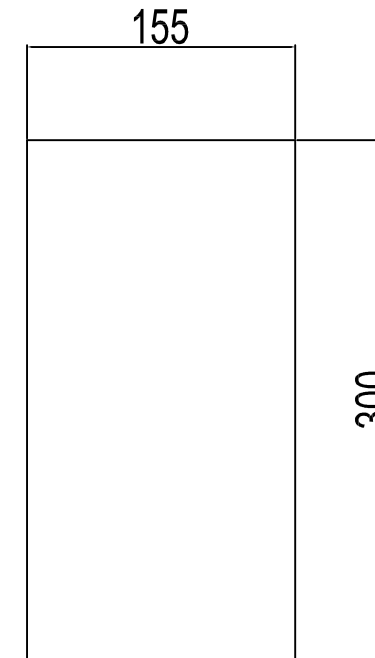

EARTHING BOSS M10

BOTTOM VIEW

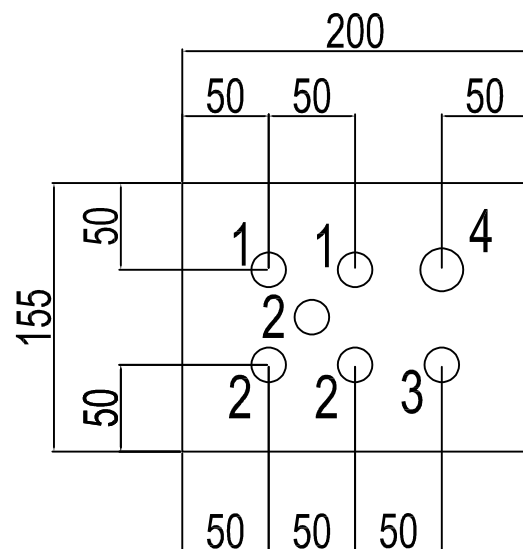

- 1 = Solenoid cable - M20
- 2 = Spare plug - M20
- 3 = Breather / Drain - M20
- 4 = Solenoid multipair cable - M25

Gland entry details must be specified

Another label same as this label with following content must be added :
"Explosion Hazard, Disconnect Signals before Maintenance"

White letter on Red background

THIS BOX CONTAINS NON-INTRINSICALLY SAFE SIGNALS

Terminal strip: X1
Make: Weidmuller
Qty: 16

Nameplate for junction box, A

Black letters on white background

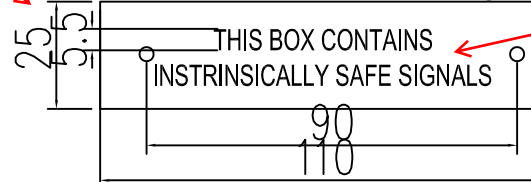

NAMEPLATE, 3:1, SS316 (typical)

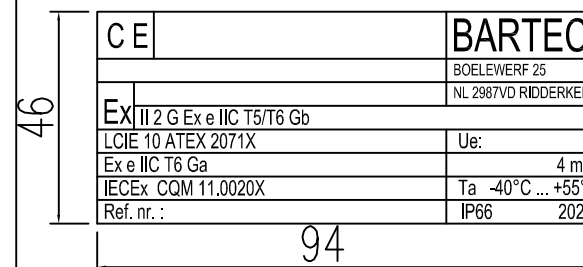

TAG.NO, 3:1, ABS JNDX-C7080-01
black letter on white background

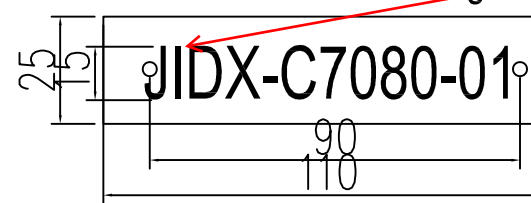

GENERAL NOTES

1. Panel material: SS316
2. Ingress protection: IP-65
3. Panel dimensions: 200x300x155 mm
4. Area classification: Eex 'e' (RAL 6021) Gray
5. All spare holes are plugged with certified plugs

Green

REFERENCE DRAWNGS	DWG.No.
xxxxxxx	xxxxxxx

REV	DATE	PURPOSE OF ISSUE (P.O.I.)	PREP.	CHKD.	APPR.	AC.
03	04/06/22	For approval	BK	RB	RB	-
02	15/06/20	For approval	DK	RD	RD	-
02	14/12/21	For approval	HT	RB	RB	-
01	18/10/21	For approval	HT	RB	RB	-
00	24/11/20	For approval	HT	RB	RB	-

CONTRACTOR:

PROJECT: BUSHEHR PETROCHEMICAL COMPANY MEG PLANT								
DRAWING TITLE: 17811-07B								
VCP/ADP/IN GENERAL ARRANGEMENT DRAWING & TERMINAL DETAILS FOR EMERGENCY INSTRUMENT AIR COMPRESSOR								
CONTRACT NO.	SCALE	SIZE	CLASS	PHASE				
52-98/445	XX	A0	1	P				
DOCUMENT NO.	PROJECT	AREA	PHASE	M/R	NO. DIS.	SEQ.	SHEET	REV. NO.
BU-20-VD-303-IN-008-008	BU-20-VD	303-IN	DWG	0089	3	OF	6	03

JIAX-C7080-01

FRONT SIDE (OUTSIDE) VIEW

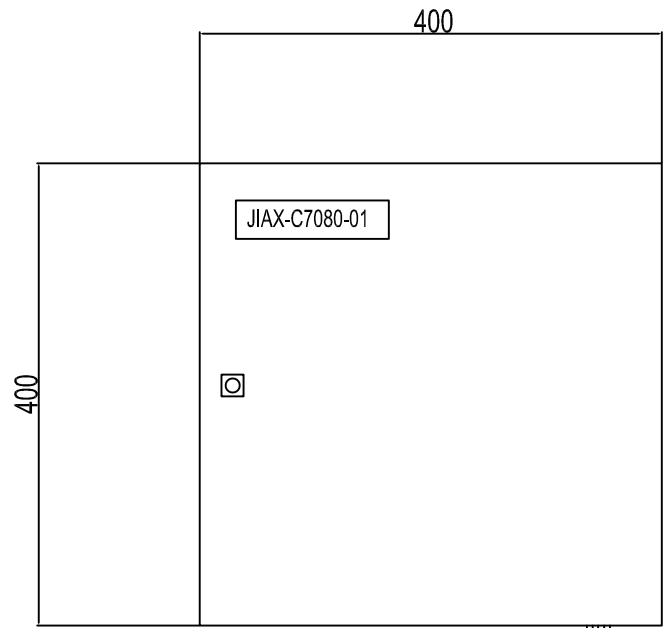

EARTHING BOSS M10

FRONT SIDE (INSIDE) VIEW

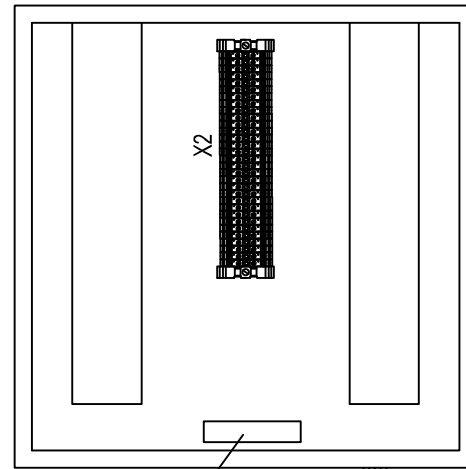

ISE Bar

EARTHING BOSS M10

SIDE (OUTSIDE) VIEW

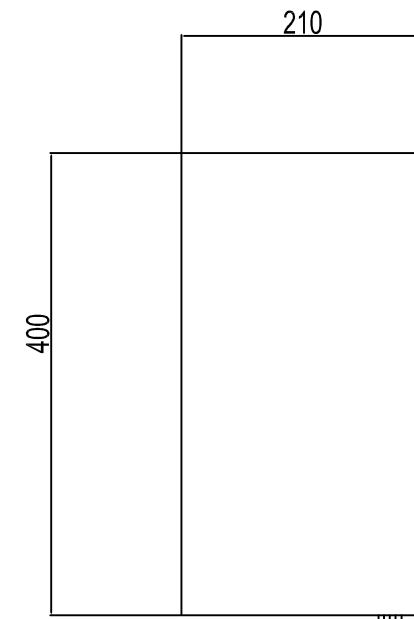

EARTHING BOSS M10

BOTTOM VIEW

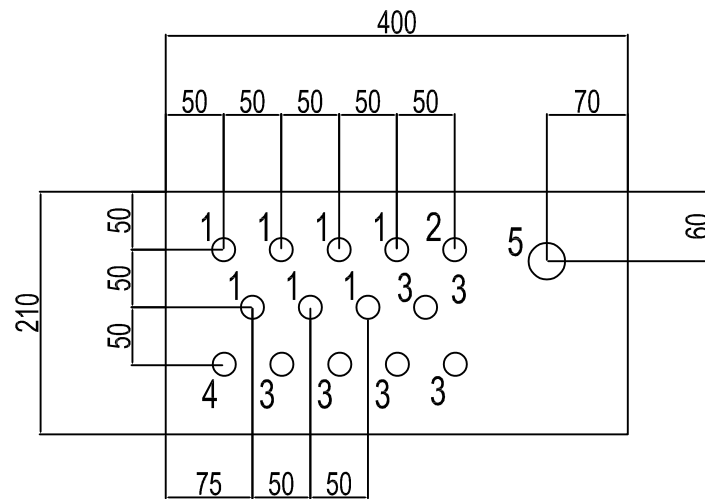

GLAND ENTRY DETAILS

M20: 1x (Breather)
 M20: 13x
 M32: 1x

10X

- 1 = Transmitter cable - M20
- 2 = PCV cable - M20
- 3 = Spare plug - M20
- 4 = Breather / Drain - M20
- 5 = Transmitter/PCV multipair cable - M32

Terminal strip: X2
 Make: Weidmuller
 Qty: 31

Nameplate for junction box
 Material: ABS
 Black letters on white background

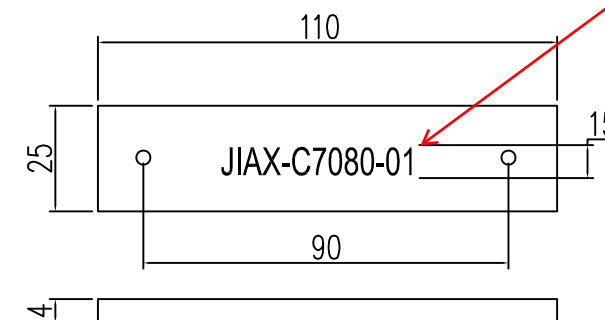

GENERAL NOTES

1. Panel material: SS316
2. Ingress protection: IP-65
3. Panel dimensions: 400x400x210 mm
4. Area classification: Eex 'i' (RAL 5015) Blue
5. All spare holes are plugged with certified plugs

REFERENCE DRAWINGS	DWG.No.
XXXXXXXX	XXXXXXXX

Repeated Comment
 This is tag plate that you specified, in addition tag plate, name plate and special label (same as attached file in previous rev.) shall be specified in this document.

REV.	DATE	PURPOSE OF ISSUE (P.O.I.)	PREP.	CHKD.	APPR.	AC.
03	04/08/22	For approval	HT	BK	RB	-
02	14/12/21	For approval	HT	RB	RB	-
01	19/10/21	For approval	HT	RB	RB	-
00	24/11/20	For approval	HT	RB	RB	-

OWNER:		MC:		CONTRACTOR:	
PROJECT:		BUSHEHR PETROCHEMICAL COMPANY		MEG PLANT	
DRAWING TITLE:		17811-07B		UPF/UP/GENERAL ARRANGEMENT DRAWING & TERMINAL DETAILS FOR EMERGENCY INSTRUMENT AIR COMPRESSOR	
CONTRACT NO.	SCALE	SIZE	CLASS	PHASE	
52-88/445	XX	A0	1	P	
DOCUMENT NO.	PROJECT	AREA	PHASE	MRQ No.	DIS.
OWNER DOC. NO.:	BU-20-VD-303-IN-DWG-0089	4 OF 6	03		

Nr	Description	Tagnumber	Make	Qty	Modelnumbers
1.	Operational lamp (green)	3H4	Schneider	1	XB4BVB3
2.	Running lamp (green)	3H6	Schneider	1	XB4BVB3
3.	Common alarm lamp (amber)	3H8	Schneider	1	XB4BVB5
4.	Common trip lamp (red)	3H10	Schneider	1	XB4BVB4
5.	Start pushbutton (green)	2S4	Schneider	1	XB4BA31
6.	Stop pushbutton (red)	2S6	Schneider	1	XB4BA42
7.	Lamp test pushbutton (black)	2S8	Schneider	1	XB4BA21
8.	Selector switch (local/off/remote)	2S10	Schneider	1	-
9.	ESD button	4S3	Schneider	1	-

GENERAL NOTES

1. Tag numbers correspond with electrical diagram
2. All the parts that are on the list in the panel layout will be included in the IOM.

REFERENCE DRAWINGS	DWG.No.
XXXXXX	XXXXXX

Nr	Description	Tagnumber	Make	Qty	Modelnumbers
X5	Terminal strip	X5...,	Weidmuller	26	WBU4
X9	Terminal strip	X9...,	Weidmuller	4	WBU4



REV	DATE	PURPOSE OF ISSUE (P.O.I.)	PREP.	CHKD.	APPR.	AC.
03	04/08/22	For approval	BK	RB	RB	-
03	15/06/22	For approval	BK	RB	RB	-
02	14/12/21	For approval	HT	RB	RB	-
01	19/10/21	For approval	HT	RB	RB	-
00	24/11/20	For approval	HT	RB	RB	-

OWNER:

MC:

CONTRACTOR:

PROJECT:

DRAWING TITLE: 17811-07B

UOP/OP/IB GENERAL ARRANGEMENT DRAWING & TERMINAL DETAILS FOR EMERGENCY INTERMEDIATE AIR COMPRESSOR

CONTRACT NO.	SCALE	SIZE	CLASS	PHASE
52-98/445	XX	A0	1	P

LP-C7080-01

FRONT SIDE (C

E (OUTSIDE) VIEW

EL:
 This document shall match "UCP/LCP/JB WIRING DIAGRAM FOR EMERGENCY INSTRUMENT AIR COMPRESSOR" document.
 All changes in "wiring diagram" document shall be added here.
 Such as Signal Lamp, Push Button and
 Moreover, Tag number for equipment shall match "wiring diagram" document.

GENERAL NOTES

1. Panel material: SS316
2. Ingress protection: IP-65
3. Panel dimensions: 400x400x210 mm
4. Area classification: Eex 'e' (RAL 6021) Gray
5. All spare holes are plugged with certified plugs
6. Additional information processed in the nameplate:

Protection degree panel
Green part circuit

- Manufacturer date
- Panel tag

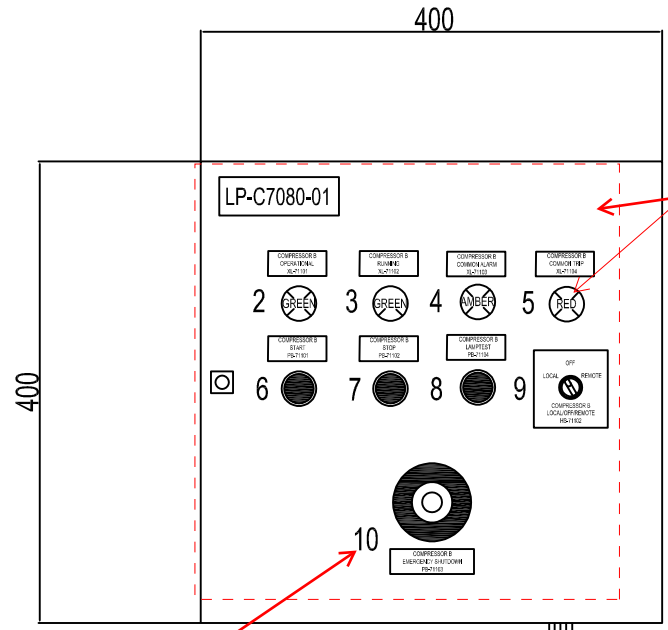

Location of name plate and label on the JB door must be specified.

EL:
 Name and Document Numbers shall be added.

Items code number must be modified according to previous page table.

EARTHING BOSS M10

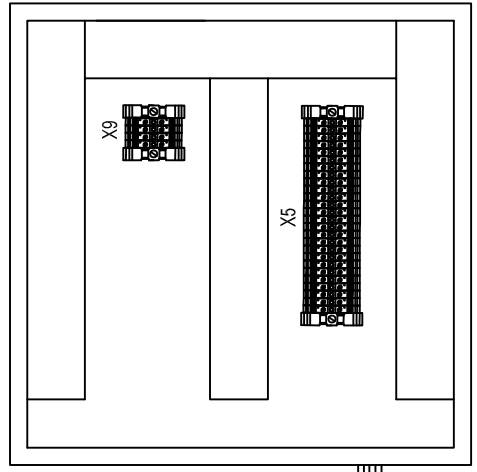

EARTHING BOSS M10

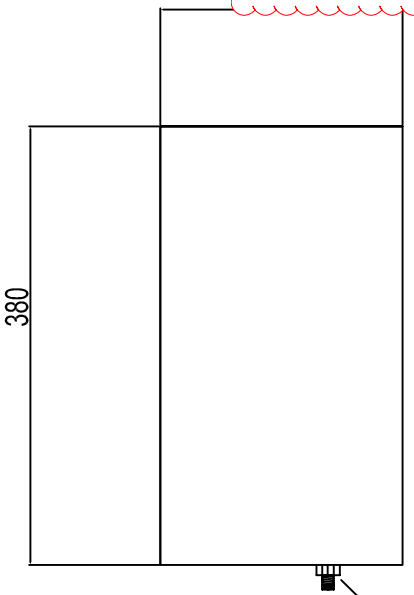

EARTHING BOSS M10

BOTTOM VIEW

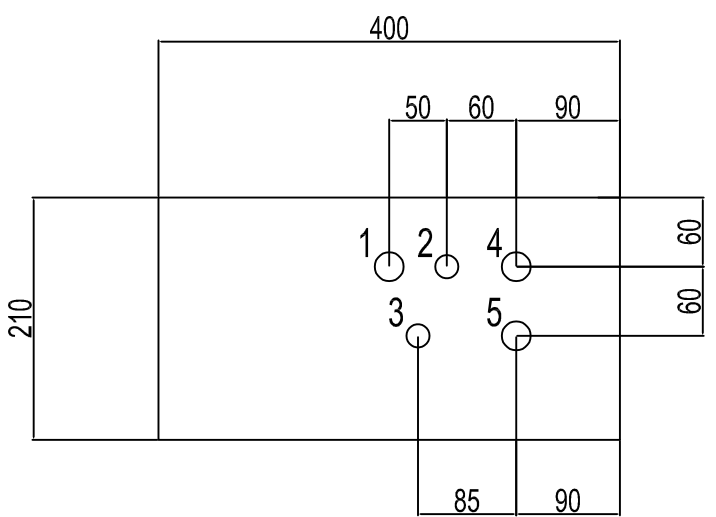

- 1 = ESD multicore cable - M25
- 2 = Spare plug - M20
- 3 = Breather / Drain - M20
- 4 = Pushbutton / Lamps multicore cable - M25
- 5 = Spare plug - M25

GLAND ENTRY DETAILS

- M20: 1x (Breather)
- M20: 1x
- M25: 3x

Another label same as this label with following content must be added :
 "Explosion Hazard, Disconnect Signals before Maintenance"

Terminal strip: X2
 Make: Weidmuller
 Qty: 61

NAMEPLATE, 3:1, SS316 (typical)

CE	BARTEC
	BOELEWERF 25
	NL 2987VD RIDDERKERK
Ex II 2 G Ex e IIC T5/T6 Gb	Ue: V
LCIE 10 ATEX 2071X	4 mm
Ex ia IIC T6 Ga	Ta -40°C ... +55°C
IECEX CQM 11.0020X	IP66
Ref. nr. :	2022

Nameplate for components on JB door (Typical)

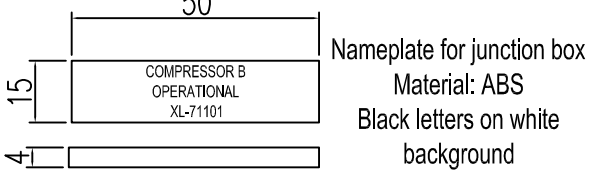

White letter on Red background

Nameplate for junction box, ABS

Black letters on white background

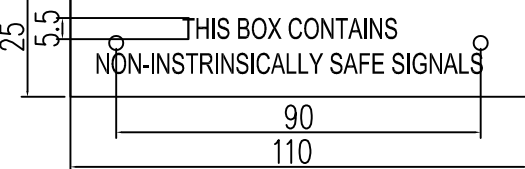

Label, 3:1, ABS
 black letter on white background

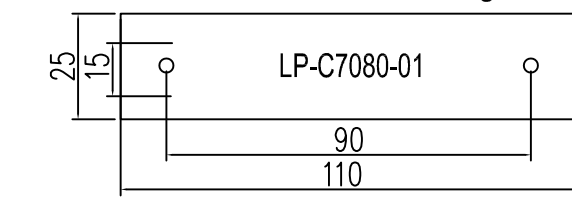

REFERENCE DRAWNGS	DWG.No.
XXXXXXXX	XXXXXXXX

REV.	DATE	PURPOSE OF ISSUE (P.O.I.)	PREP.	CHKD.	APPR.	AC.
03	04/06/22	For approval	BK	RB	RB	-
02	16/06/20	For approval	BK	RD	RD	-
02	14/12/21	For approval	HT	RB	RB	-
01	18/10/21	For approval	HT	RB	RB	-
00	24/11/20	For approval	HT	RB	RB	-

OWNER:

CONTRACTOR:

PROJECT: BUSHEHR PETROCHEMICAL COMPANY MEG PLANT

DRAWING TITLE: 17811-07B

UCP/LCP/JB GENERAL ARRANGEMENT DRAWING & TERMINAL DETAILS FOR EMERGENCY INSTRUMENT AIR COMPRESSOR

CONTRACT NO.	SCALE	SIZE	CLASS	PHASE
52-98/445	XX	A0	1	P