







OWNER:  شرکت سست و سویی ژنر ایرانیان (سهامی خاص)	<b>BUSHEHR PETROCHEMICAL COMPANY MEG PLANT</b>						EPC CONTRACTOR:  Chagalesh-Enerchimi-Steam Joint Venture BUPC-MEG PLANT PROJECT		
	<b>SINGLE LINE DIAGRAM FOR POWER DISTRIBUTION PANEL FOR EMERGENCY INSTRUMENT AIR COMPRESSOR</b>						 Netherlands		
MC :  شرکت سست و سویی ژنر ایرانیان (سهامی خاص)	Project	Area	Phase	Unit	Dis.	Doc.	Seq.	Contract No : 52-98/445	
Owner Document Number: <b>17811-49B</b>	BU	20	VD	303	EL	DIG	0097	Rev.:	Page
								06	1 of 4

## SINGLE LINE DIAGRAM FOR POWER DISTRIBUTION PANEL FOR EMERGENCY INSTRUMENT AIR COMPRESSOR

 شرکت سست و سویی ژنر ایرانیان (سهامی خاص)		 Chagalesh-Enerchimi-Steam Joint Venture BUPC-MEG PLANT PROJECT		<b>BUSHEHR PETROCHEMICAL COMPANY MEG PLANT</b>	
<b>Document Review</b>					
Issue Purpose:			IFA		
Result Code: AP,AN,CM,RE,NC			AN		
Next Status : IFC,IFA,IFI,AFC,AB			AFC		
Responsible Department			MECHANICAL		
Commented Date			Sep/21/2022		
<b>Approval or review hereunder shall not be construed to relieve Vendor / Subcontractor of his responsibilities and liability under the contract.</b>					

06	14/09/2022	For approval	BK	RB	KP	
05	27/07/2022	For approval	BK	RB	KP	
04	28/06/2022	For approval	DH	RB	KP	
03	21/03/2022	For approval	AS	RB	KP	
02	10/01/2022	For approval	HT	RB	KP	
01	19/10/2021	For approval	HT	RB	KP	
00	02/07/2021	For approval	HT	RB	KP	
<b>Rev.</b>	<b>Date</b>	<b>Purpose of Issue</b>	<b>Prepared</b>	<b>Checked</b>	<b>Approved</b>	<b>AC Code</b>
				Class: 1	Phase: P	



# LEGEND

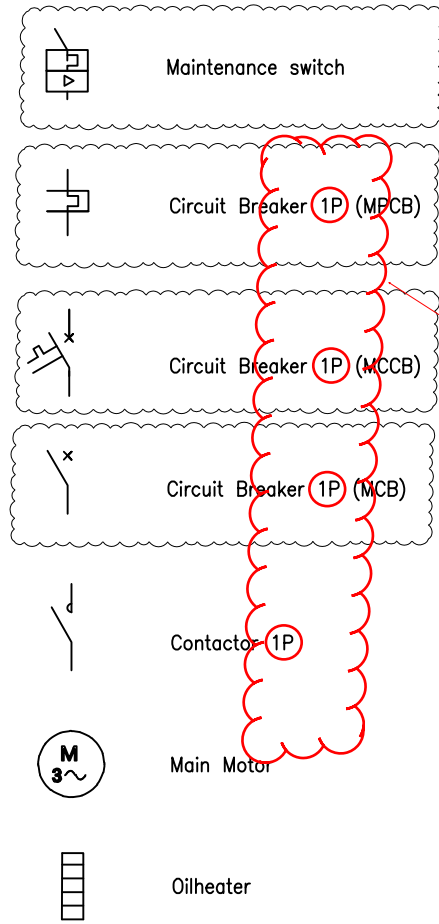

to be corrected. 2P shall be used.

NOTES:



SUBJECT		BUSHEHR PETROCHEMICAL COMPANY MEG PLANT EMERGENCY INSTRUMENT AIR COMPRESSOR		DATE	14-09-2022	THIS DRAWING IS OWNED BY AIRPACK AND SHALL NOT BE PRINTED OR COPIED IN ANY OTHER WAY THAN WITH AIRPACKS PERMISSION			
				DRAWN BY	HT		REV 05	14-09-2022	BK
				CHECKED BY	KP		REV 04	25-07-2022	BK
CLIENT	BUSHEHR PETROCHEMICAL COMPANY (BUPC)			PLANT LOCATION	IRAN		REV 03	28-06-2022	DH
CLIENT REF	20-C-7080			DRAWING NO.	17811-49B	REV 02	18-03-2022	AS	
AIRPACK REF	17811			SHEETNO.	01 /13	REV 01	10-01-2022	HT	
						REV 00	19-10-2021	HT	

SINGLE LINE DIAGRAM

EBP-20-C-7080-M

From: SWB3A-03  
 Cable no: EBP-20-C-1002-M  
 Cable Type and Size: CU/XLPE/SWA/PVC3.5\*50mm2  
 Gland: EX-IP65 E/M40

UPS-1  
 POWER SUPPLY  
 110VAC 50 HZ  
 3X2.5 mm2

UPS-2  
 POWER SUPPLY  
 110VAC 50 HZ  
 3X2.5 mm2

NON-UPS  
 POWER SUPPLY  
 230VAC 50 HZ  
 3X2.5 mm2

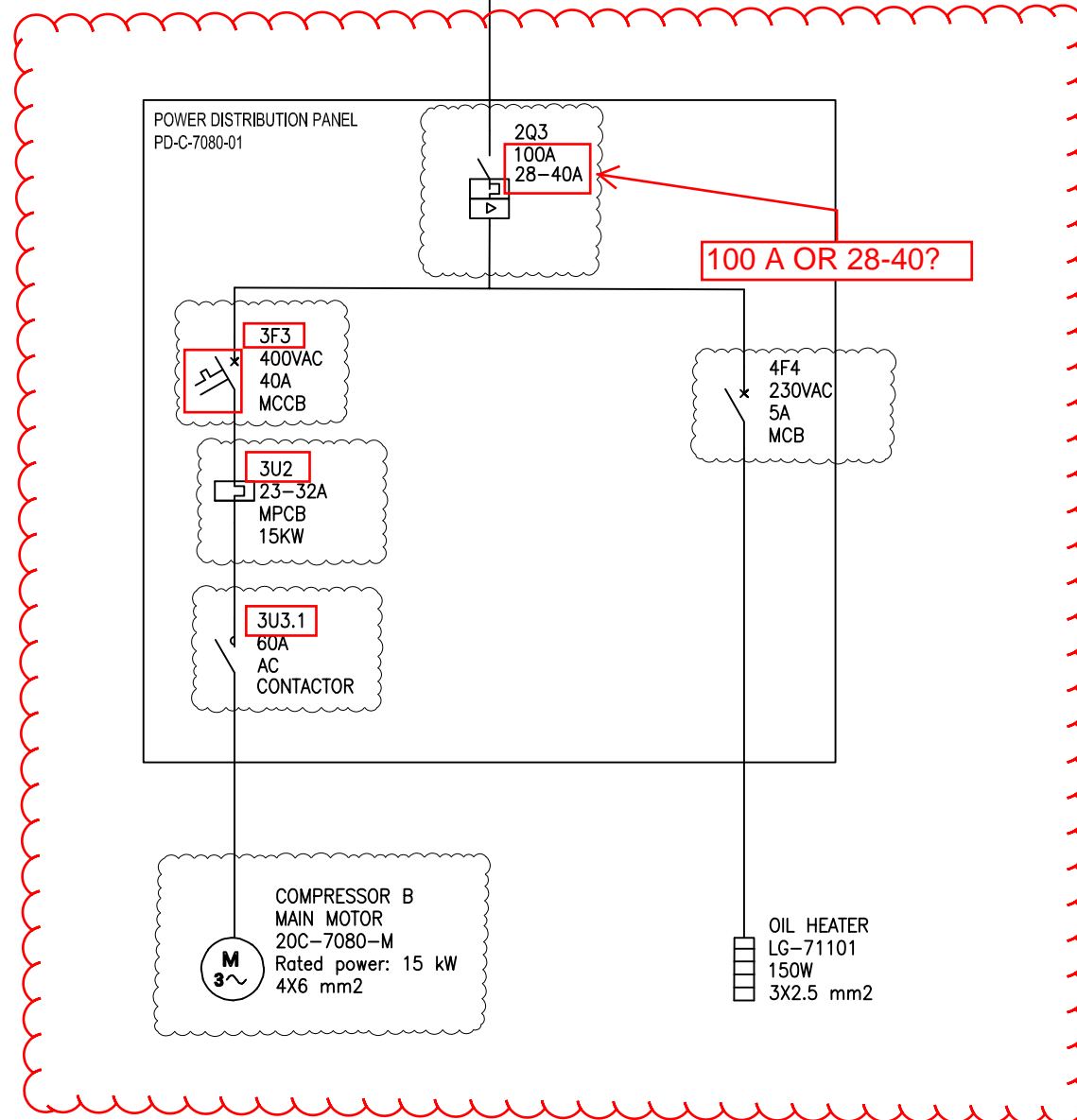

100 A OR 28-40?

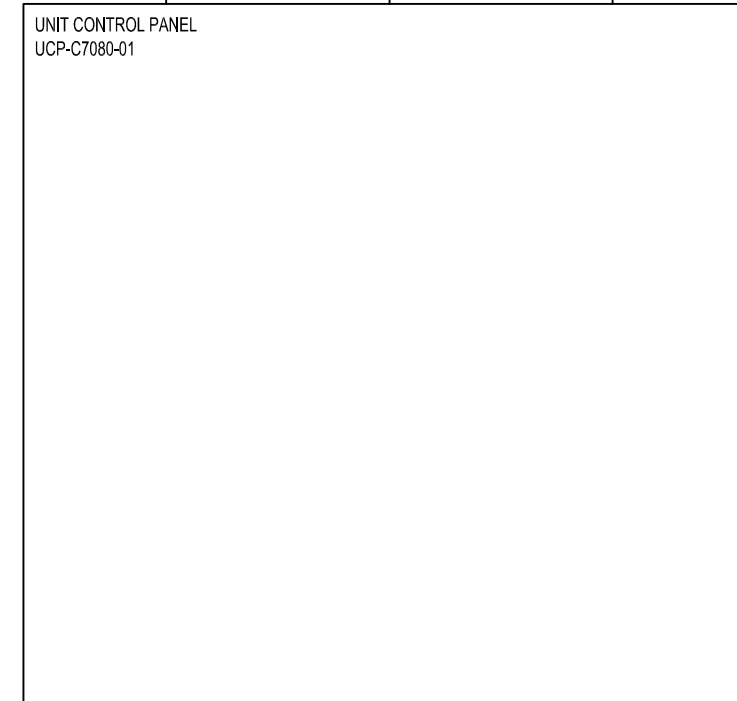

TAG NO FOR DEVICES TO BE CHECKED  
 ACCORDING TO BU-20-VD-303-EL-DWG-0059

NOTES:

	SUBJECT BUSHEHR PETROCHEMICAL COMPANY MEG PLANT EMERGENCY INSTRUMENT AIR COMPRESSOR		DATE 14-09-2022	THIS DRAWING IS OWNED BY AIRPACK AND SHALL NOT BE PRINTED OR COPIED IN ANY OTHER WAY THAN WITH AIRPACKS PERMISSION	REV 05	14-09-2022	BK
	CLIENT BUSHEHR PETROCHEMICAL COMPANY (BUPC)	PLANT LOCATION IRAN	DRAWN BY HT		REV 04	25-07-2022	BK
CLIENT REF 20-C-7080	DRAWING NO. 17811-49B	CHECKED BY KP	REVISIONS	REV 03	28-06-2022	DH	
AIRPACK REF 17811	SHEETNO. 02 / 13			REV 02	18-03-2022	AS	
				REV 01	10-01-2022	HT	
				REV 00	19-10-2021	HT	