







OWNER:  شرکت سست و سویی توسعه ایرانین (سامی خاص)	BUSHEHR PETROCHEMICAL COMPANY MEG PLANT							EPC CONTRACTOR:  Chagalesh-Enerchimi-Steam Joint Venture BUPC-MEG PLANT PROJECT	
	NDE PROCEDURE							 Contract No : 52-98/445	
MC :  شرکت سست و سویی توسعه ایرانین (سامی خاص)	Project	Area	Phase	Unit	Dis.	Doc.	Seq.	Contract No : 52-98/445	
Owner Document Number: 17811-15	BU	20	VD	303	QC	PRC	0007	Rev.:	Page
								04	1 of 41

NDE PROCEDURE

 شرکت پترو شیمی بوشهر  شرکت سست و سویی توسعه ایرانین	 Chagalesh-Enerchimi-Steam Joint Venture BUPC-MEG PLANT PROJECT	BUSHEHR PETROCHEMICAL COMPANY MEG PLANT
Document Review		
Issue Purpose:	AFC	
Result Code: AP,AN,CM,RE,NC	AP	
Next Status : IFC,IFA,IFI,AFC,AB	-	
Responsible Department	INSPECTION	
Commented Date		
Approval or review hereunder shall not be construed to relieve Vendor / Subcontractor of his responsibilities and liability under the contract.		

Rev.	Date	Purpose of Issue	Prepared	Checked	Approved	AC Code		
04	11/10/2022	Approved for Construction	KP	LdM	JR			
03	19/05/2022	For approval	KP	LdM	JR			
02	25/03/2022	For approval	KP	LdM	JR			
01	12/11/2021	For approval	KP	LdM	JR			
00	08/12/2020	For approval	KP	KP	PW			
<table border="1" style="display: inline-table; border-collapse: collapse;"> <tr> <td style="padding: 2px;">Class: 1</td> <td style="padding: 2px;">Phase: P</td> </tr> </table>							Class: 1	Phase: P
Class: 1	Phase: P							

Doc Ref : RT 21034
 Revision : 2
 Date : 16-12-2019
 Title : Radiographic assessment
 Type : Standard procedure



RADIOGRAPHIC ASSESSMENT PROCEDURE

Procedure for:

Radiographic assessment standard for welds

In accordance with the requirements of:

ASME B31.3 edition 2018, table 341.3.2.

Development – Revisions					
Revision No.	Prepared By	Date	Approved By	Date	Amendment Details
2	M. Vondenhoff	16-12-2019	T. Cornelissen	16-12-2019	Updated to latest edition, ASME B31.3 table 341.3.2 edition 2018
1		07-08-2018			
0		14-01-2014			

 Applus+ RTD L3 MT/PT/UT M. Vondenhoff	 Applus+ RTD L3 MT/PT/RT/UT T.A.F. Cornelissen	Digitally signed by Theo Cornelissen Date: 2019.12.16 14:18:10 +01'00'
Date: 16-12-2019	Date: 16-12-2019	Date:

Address
 Delftweg 144, 3046 NC Rotterdam
 P.O. Box 10065, 3004 AB Rotterdam
 The Netherlands
www.ApplusRTD.com

This publication is the intellectual property of Applus+ RTD and may not be used in whole or in part for any purpose other than the business of Applus+ RTD and may not be used for the business of the recipient and may not be passed to any other person without the permission of Applus+ RTD.

Doc Ref : RT 21034
Revision : 2
Date : 16-12-2019
Title : Radiographic assessment
Type : Standard procedure

Contents

1	Scope	3
2	References and abbreviations	3
2.1	<i>Applus+ RTD documents</i>	3
2.2	<i>Codes and standards</i>	3
2.3	<i>Abbreviations</i>	3
2.4	<i>Terminology</i>	3
3	Personnel qualifications	3
4	Facilities for viewing of radiographs	4
4.1	<i>Radiographic density limitations</i>	4
5	Acceptance criteria	4
6	Acceptance criteria for rounded indications	9
6.1	<i>Image density</i>	9
6.2	<i>Rounded indication charts</i>	9
6.3	<i>Relevant rounded indications</i>	9
6.4	<i>Maximum size of rounded indications</i>	9
6.5	<i>Aligned rounded indications</i>	10
6.6	<i>Clustered indications</i>	10
6.7	<i>Spacing</i>	10
6.8	<i>Weld thickness t less than 3.0 mm</i>	10
	Rounded indication charts	11

1 Scope

This procedure defines the radiographic assessment standard for welds in accordance with the requirements of:

- ASME B31.3 edition 2018, table 341.3.2.

2 References and abbreviations

2.1 *Applus+ RTD documents*

- NL-10 Written practice for the Training, Qualification, Certification and Authorization of NDT Personnel.
- CP 31003 Verification procedure for film densitometers.
- CP 31014 Verification procedure for illuminators used for industrial radiographs.

2.2 *Codes and standards*

- ASME B31.3: 2018 Process Piping – ASME Code for pressure piping, B31.
- ASME BPVC VIII.1:2019 ASME Boiler and Pressure Vessel Code, Division 1.
- ISO 9712 Qualification and certification of NDT personnel.
- SNT TC 1A Personnel qualification and certification in NDT.

2.3 *Abbreviations*

NDE	Non Destructive Examination
RT	Radiographic Testing
t	Nominal wall thickness
T_w	Nominal wall thickness plus the allowable external reinforcement and internal reinforcement (protrusion) combined
w	Penetrated thickness

2.4 *Terminology*

Rounded indications

Indications with a maximum length of three times the width or less on the radiograph are defined as rounded indications. These indications may be circular, elliptical, conical or irregular in shape and may have tails. When evaluating the size of an indication, the tail shall be included. The indication may be from any imperfection in the weld, such as porosity, slag or tungsten.

Aligned indications

A sequence of four or more rounded indications shall be considered to be aligned when they touch a line parallel to the length of the weld drawn through the centre of the two outer rounded indications.

Thickness (t)

t is the thickness of the weld, excluding any allowable reinforcement. For a butt weld joining two members having different thicknesses at the weld, t is the thinner of these two thicknesses. If a full penetration weld includes a fillet weld, the thickness of the fillet weld throat shall be included in t .

3 Personnel qualifications

NDE-personnel shall be qualified and certified in accordance with the valid version of Applus+ RTD Written Practice, which is in conformity with the Recommended Practice SNT-TC-1A and ISO 9712.

The assessment of the films shall be performed only by personnel RT level 2 (inclusive film interpretation) as minimum.

4 Facilities for viewing of radiographs

The proper assessment of image quality and accurate reporting on the diagnostic information of the radiographs shall be achieved by:

- The maximum density of the film assessed shall never exceed the light intensity incident of the viewer.
- The film viewer and lamps used shall be acceptable according Applus+ RTD verification procedure CP 31014.
- No light sources with a strength > 50 Lux shall be visible when assessing the radiograph, to avoid dazzling.
- Means for magnifying details in the displayed radiographic image should be available. The magnifying glass shall be max 7x.
- The ambient light intensity measured on the film viewer (with the film viewer off) shall be ≤ 20 Lux.

4.1 Radiographic density limitations

The transmitted film density through the radiographic image of the body of the appropriate IQI and the area of interest shall be 1.8 minimum for single film viewing for radiographs made with an X-ray source and 2.0 minimum for radiographs made with a gamma ray source.

The maximum density shall be 4.0 for either single or composite viewing. A tolerance of 0.05 in density is allowed for variations between densitometer readings.

5 Acceptance criteria

Indications shown on radiographs of welds and characterized as imperfections are unacceptable under the following conditions as stated into ASME B31.3, table 341.3.2 for the service conditions discussed.

If no service condition is given the "Severe Cyclic Condition" shall be used.

ASME B31.3-2018

Figure 341.3.2 Typical Weld Imperfections

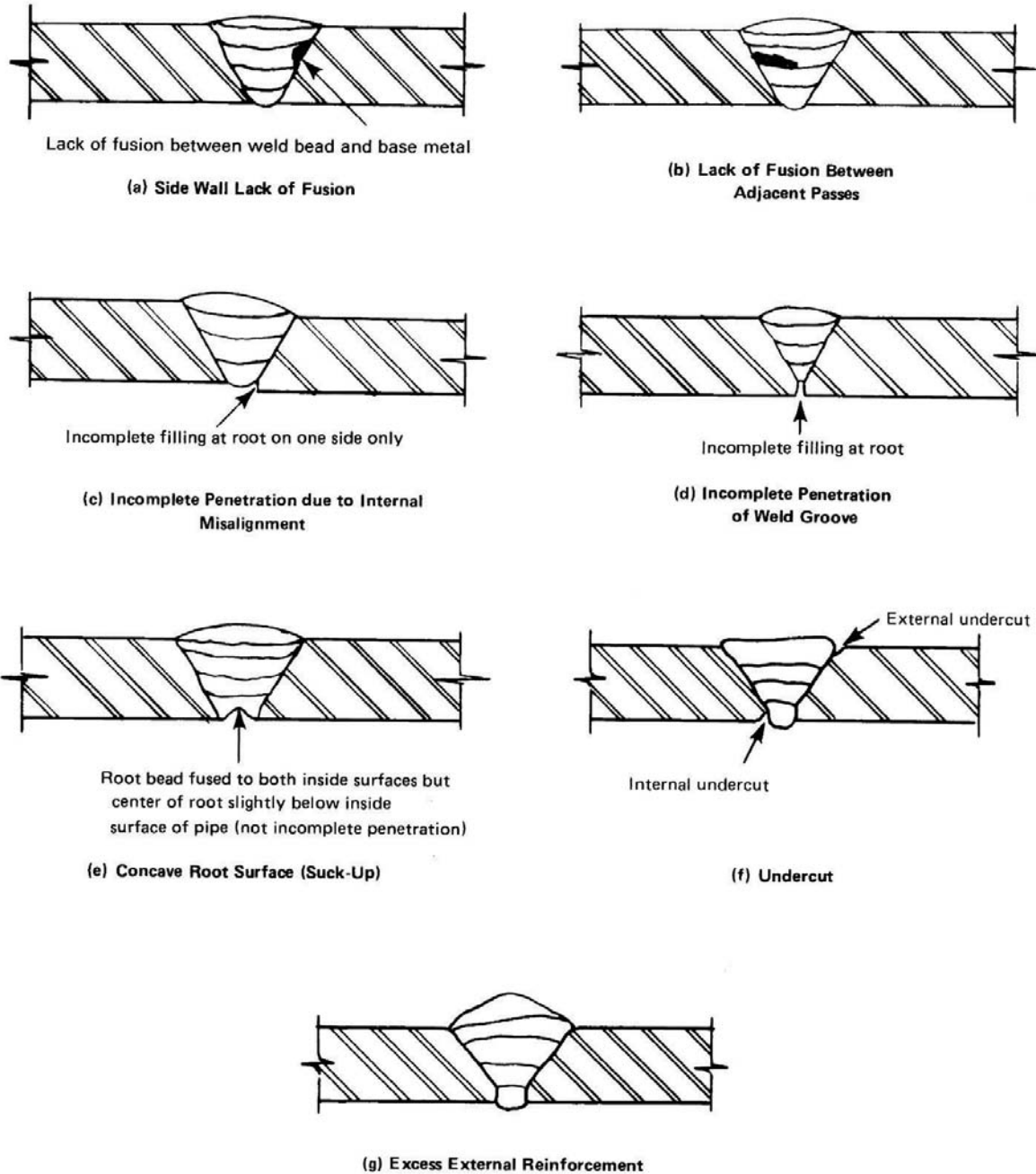

Table 341.3.2 Acceptance Criteria for Welds — Visual and Radiographic Examination

Criteria (A to M) for Types of Welds and for Service Conditions [Note (1)]										Examination Methods		
Normal and Category M Fluid Service			Severe Cyclic Conditions				Category D Fluid Service			Visual	Radiography	
Girth, Miter Groove, and Branch Connection Welds [Note (2)]	Longitudinal Groove Weld [Note (3)]	Fillet Weld [Note (4)]	Girth, Miter Groove, and Branch Connection Welds [Note (2)]	Longitudinal Groove Weld [Note (3)]	Fillet Weld [Note (4)]	Girth and Miter Groove Welds	Longitudinal Groove Weld [Note (3)]	Fillet Weld [Note (4)]	Branch Connection Weld [Note (2)]			
A	A	A	A	A	A	A	A	A	A	Crack	✓	✓
A	A	A	A	A	A	C	A	N/A	A	Lack of fusion	✓	✓
B	A	N/A	A	A	N/A	C	A	N/A	B	Incomplete penetration	✓	✓
E	N/A	N/A	D	D	N/A	N/A	N/A	N/A	N/A	Rounded Indications	...	✓
G	N/A	N/A	F	F	N/A	N/A	N/A	N/A	N/A	Linear indications	...	✓
H	A	H	A	A	A	I	A	H	H	Undercutting	✓	✓
A	A	A	A	A	A	A	A	A	A	Surface porosity or exposed slag inclusion [Note (5)]	✓	...
N/A	N/A	N/A	J	J	N/A	N/A	N/A	N/A	N/A	Surface finish	✓	...
K	K	N/A	K	K	N/A	K	K	N/A	K	Concave surface, concave root, or burn-through	✓	✓
L	L	L	L	L	L	M	M	M	M	Weld reinforcement or internal protrusion	✓	...

GENERAL NOTES:

- (a) Weld imperfections are evaluated by one or more of the types of examination methods given, as specified in paras. 341.4.1, 341.4.2, 341.4.3, and M341.4, or by the engineering design.
- (b) "N/A" indicates the Code does not establish acceptance criteria or does not require evaluation of this kind of imperfection for this type of weld.
- (c) Check (✓) indicates examination method generally used for evaluating this kind of weld imperfection.
- (d) Ellipsis (...) indicates examination method not generally used for evaluating this kind of weld imperfection.

NOTES:

- (1) Criteria given are for required examination. More-stringent criteria may be specified in the engineering design. See also paras. 341.5 and 341.5.3.
- (2) Branch connection weld includes pressure containing welds in branches and fabricated laps.
- (3) Longitudinal groove weld includes straight and spiral (helical) seam. Criteria are not intended to apply to welds made in accordance with a standard listed in Table A-1, Table A-1M, or Table 326.1. Alternative Leak Test requires examination of these welds; see para. 345.9.
- (4) Fillet weld includes socket and seal welds, and attachment welds for slip-on flanges, branch reinforcement, and supports.
- (5) These imperfections are evaluated only for welds ≤5 mm (3/16 in.) in nominal thickness.

Criterion Value Notes for Table 341.3.2

Symbol	Criterion	Measure	Acceptable Value Limits [Note (1)]
A	Extent of imperfection		Zero (no evident imperfection)
B	Cumulative length of incomplete penetration		≤38 mm (1.5 in.) in any 150 mm (6 in.) weld length or 25% of total weld length, whichever is less
C	Cumulative length of lack of fusion and incomplete penetration		≤38 mm (1.5 in.) in any 150 mm (6 in.) weld length or 25% of total weld length, whichever is less
D	Size and distribution of rounded indications		See ASME BPVC, Section VIII, Division 1, Appendix 4 [Note (2)]
E	Size and distribution of rounded indications		For $\bar{T}_{1w} \leq 6$ mm ($1/4$ in.), limit is same as D [Note (2)] For $\bar{T}_{1w} > 6$ mm ($1/4$ in.), limit is $1.5 \times D$ [Note (2)]
F	Linear indications		≤ $\bar{T}_{1w}/3$
	Individual length		≤2.5 mm ($3/32$ in.) and ≤ $\bar{T}_{1w}/3$
	Individual width		≤ \bar{T}_{1w} in any 12 \bar{T}_{1w} weld length [Note (2)]
G	Cumulative length		≤2 \bar{T}_{1w}
	Linear indications		≤3 mm ($1/8$ in.) and ≤ $\bar{T}_{1w}/2$
	Individual length		≤4 \bar{T}_{1w} in any 150 mm (6 in.) weld length [Note (2)]
	Individual width		≤1 mm ($1/32$ in.) and ≤ $\bar{T}_{1w}/4$
	Cumulative length		≤38 mm (1.5 in.) in any 150 mm (6 in.) weld length or 25% of total weld length, whichever is less
H	Depth of undercut		≤1.5 mm ($1/16$ in.) and ≤ $\bar{T}_{1w}/4$ or 1 mm ($1/32$ in.)
	Cumulative length of internal and external undercut		≤38 mm (1.5 in.) in any 150 mm (6 in.) weld length or 25% of total weld length, whichever is less
I	Depth of undercut		≤38 mm (1.5 in.) in any 150 mm (6 in.) weld length or 25% of total weld length, whichever is less
	Cumulative length of internal and external undercut		≤12.5 μm (500 μin.) R_a in accordance with ASME B46.1
J	Surface roughness		Total joint thickness, including weld reinforcement, ≥ \bar{T}_{1w} [Notes (3) and (4)]
K	Depth of surface concavity, root concavity, or burn-through		For \bar{T}_{1w} mm (in.) ≤6 ($1/4$) >6 ($1/4$), ≤13 ($1/2$) >13 ($1/2$), ≤25 (1) >25 (1)
L	Height of reinforcement or internal protrusion [Note (5)] in any plane through the weld shall be within limits of the applicable height value in the tabulation at right, except as provided in Note (6). Weld metal shall merge smoothly into the component surfaces.		Height, mm (in.) ≤1.5 ($1/16$) ≤3 ($1/8$) ≤4 ($3/32$) ≤5 ($3/16$)
M	Height of reinforcement or internal protrusion [Note (5)] as described in L, Note (6) does not apply.		Limit is twice the value applicable for L, above

NOTES:

(1) Where two limiting values are separated by "and," the lesser of the values determines acceptance. Where two sets of values are separated by "or," the larger value is acceptable. \bar{T}_{1w} is the nominal wall thickness of the thinner of two components joined by a butt weld.

Criterion Value Notes for Table 341.3.2 (Cont'd)

NOTES: (Cont'd)

- (2) Porosity and inclusions such as slag or tungsten are defined as rounded indications where the maximum length is three times the width or less. These indications may be circular, elliptical, or irregular in shape; may have tails; and may vary in density. Indications where the length is greater than three times the width are defined as linear indications and may also be slag, porosity, or tungsten.
- (3) For circumferential groove welded joints in pipe, tube, and headers made entirely without the addition of filler metal, external concavity shall not exceed the lesser of 1 mm ($1/32$ in.) or 10% of the joint nominal thickness. The contour of the concavity shall blend smoothly with the base metal. The total joint thickness, including any reinforcement, shall not be less than the minimum wall thickness, t_{min} .
- (4) For radiography, acceptability may be determined by comparing the density of the image through the affected area to the density through the adjacent base metal (\bar{T}_p). If digital radiography is used, brightness comparison may be utilized. A density or brightness darker than the adjacent base metal is cause for rejection.
- (5) For groove welds, height is the lesser of the measurements made from the surfaces of the adjacent components; both reinforcement and internal protrusion are permitted in a weld. For fillet welds, height is measured from the theoretical throat. Figure 328.5.2A; internal protrusion does not apply.
- (6) For welds in aluminum alloy only, internal protrusion shall not exceed the following values:
- (a) 1.5 mm ($1/16$ in.) for thickness ≤ 2 mm ($5/64$ in.)
 - (b) 2.5 mm ($3/32$ in.) for thickness > 2 mm and ≤ 6 mm ($1/4$ in.)
- For external reinforcement and for greater thicknesses, see the tabulation for symbol L.

6 Acceptance criteria for rounded indications

6.1 Image density

Density within the image of the indication may vary and is not a criterion for acceptance or rejection.

6.2 Rounded indication charts

Rounded indications shall be assessed according to ASME BPVC VIII division 1, mandatory appendix 4 rounded indications charts acceptance standard for radiographically determined rounded indications in welds.

Relevant rounded indications characterized as imperfections shall not exceed those shown in figures 4.1 through figure 4.6, which illustrate various types of assorted, randomly dispersed and clustered rounded indications for different weld thicknesses greater than 3 mm.

These charts represent the maximum acceptable concentration limits for rounded indications. The charts for each thickness range represent full-scale 150 mm radiographs, and shall not be enlarged or reduced.

The distributions shown are not necessarily the patterns that may appear on the radiograph, but are typical of the concentration and size of indications permitted.

6.3 Relevant rounded indications

Only those rounded indications which exceed the following dimensions shall be considered relevant (see table 4.1 for examples) and compared to the acceptance charts for disposition:

1/10t	for $t < 3.0$ mm.
0.4 mm	for $3 \text{ mm} \leq t < 6$ mm.
0.8 mm	for $6 \text{ mm} \leq t < 50$ mm.
1.5 mm	for $t > 50$ mm.

Radiographic acceptance standard for rounded indications (Examples only)

Table 4-1				SI Units			
Customary Units				Maximum Size of Acceptable Rounded Indication, mm			
Thickness, t , in.	Maximum Size of Acceptable Rounded Indication, in.		Maximum Size of Nonrelevant Indication, in.	Thickness, t , mm	Maximum Size of Acceptable Rounded Indication, mm		Maximum Size of Nonrelevant Indication, mm
	Random	Isolated			Random	Isolated	
Less than 1/8	1/4 t	1/3 t	1/10 t	Less than 3	1/4 t	1/3 t	1/10 t
1/8	0.031	0.042	0.015	3	0.79	1.07	0.38
3/16	0.047	0.063	0.015	5	1.19	1.60	0.38
1/4	0.063	0.083	0.015	6	1.60	2.11	0.38
5/16	0.078	0.104	0.031	8	1.98	2.64	0.79
3/8	0.091	0.125	0.031	10	2.31	3.18	0.79
7/16	0.109	0.146	0.031	11	2.77	3.71	0.79
1/2	0.125	0.168	0.031	13	3.18	4.27	0.79
9/16	0.142	0.188	0.031	14	3.61	4.78	0.79
5/8	0.156	0.210	0.031	16	3.96	5.33	0.79
11/16	0.156	0.230	0.031	17	3.96	5.84	0.79
3/4 to 2, incl.	0.156	0.250	0.031	19.0 to 50, incl.	3.96	6.35	0.79
Over 2	0.156	0.375	0.063	Over 50	3.96	9.53	1.60

GENERAL NOTE: This Table contains examples only.

6.4 Maximum size of rounded indications

The maximum permissible size of any rounded indication shall be:

1/4t, or 4 mm, whichever is smaller.

Except that an isolated indication separated from an adjacent indication by 25 mm or more may be 1/3t, or 6 mm, whichever is less. For t greater than 50 mm, the maximum permissible size of an isolated indication shall be increased to 10 mm.

Doc Ref : RT 21034
Revision : 2
Date : 16-12-2019
Title : Radiographic assessment
Type : Standard procedure

6.5 Aligned rounded indications

Aligned rounded indications are acceptable when the summation of the diameters of the indications is less than t in a length of $12t$. See figure 7.3.

The length of groups of aligned rounded indications and the spacing between the groups shall meet the requirements of figure 7.4.

6.6 Clustered indications

The illustrations for clustered indications show up to four times as many indications in a local area, as that shown in the illustrations for random indications. The length of an acceptable cluster shall not exceed the lesser of 25 mm or $2t$. Where more than one cluster present, the sum of the lengths of the clusters shall not exceed 25 mm in a 150 mm length weld.

6.7 Spacing

The distance between adjacent rounded indications is not a factor in determining acceptance or rejection, except as required for isolated indications or groups of aligned indications.

6.8 Weld thickness t less than 3.0 mm

For t less than 3.0 mm the maximum number of rounded indications shall not exceed 12 in a 150 mm length of weld. A proportionally fewer number of indications shall be permitted in welds less than 150 mm in length.

Rounded indication charts

ASME BPVC VIII division 1, mandatory appendix 4 rounded indications charts acceptance standard for radiographically determined rounded indications in welds.

Figure 4-1
Aligned Rounded Indications

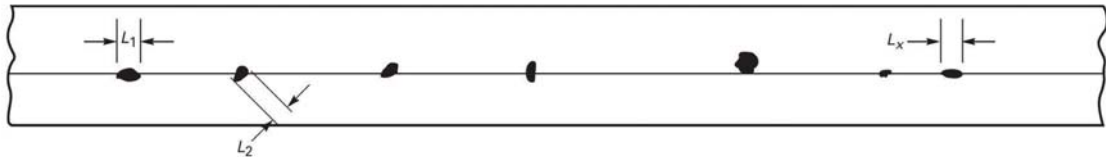

GENERAL NOTE: Sum of L_1 to L_x shall be less than t in a length of $12t$.

Figure 4-2
Groups of Aligned Rounded Indications

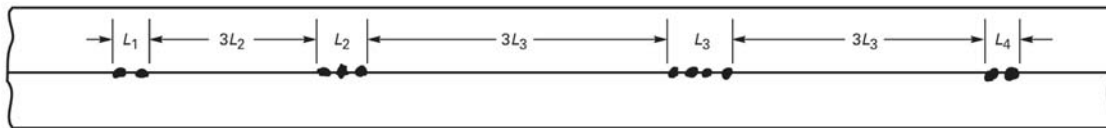

Maximum Group Length
 $L = 1/4$ in. (6 mm) for t less than $3/4$ in. (19 mm)
 $L = 1/3 t$ for t $3/4$ in. (19 mm) to $2 1/4$ in. (57 mm)
 $L = 3/4$ in. (19 mm) for t greater than $2 1/4$ in. (57 mm)

Minimum Group Spacing
 $3L$ where L is the length of the longest adjacent group being evaluated

GENERAL NOTE: Sum of the group lengths shall be less than t in a length of $12t$.

Figure 4-3
Charts for t Equal to $1/8$ in. to $1/4$ in. (3 mm to 6 mm), Inclusive

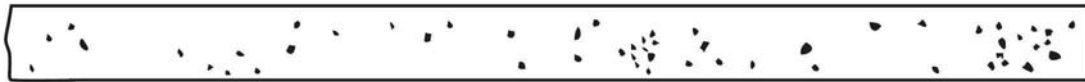

(a) Random Rounded Indications [See Note (1)]

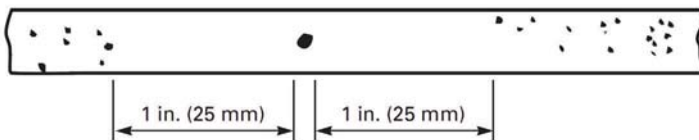

(b) Isolated Indication [See Note (2)]



(c) Cluster

NOTES:

(1) Typical concentration and size permitted in any 6 in. (150 mm) length of weld.

(2) Maximum size per Table 4-1.

Figure 4-4
Charts for t Over $\frac{1}{4}$ in. to $\frac{3}{8}$ in. (6 mm to 10 mm), Inclusive

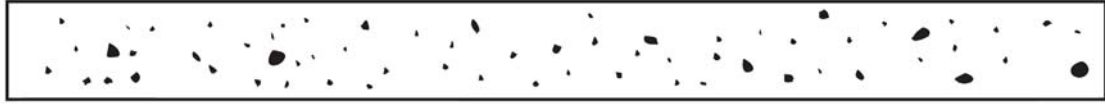

(a) Random Rounded Indications [See Note (1)]

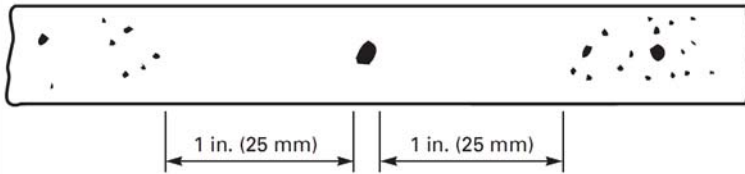

(b) Isolated Indication [See Note (2)]



(c) Cluster

NOTES:

- (1) Typical concentration and size permitted in any 6 in. (150 mm) length of weld.
- (2) Maximum size per Table 4-1.

Figure 4-5
Charts for t Over $\frac{3}{8}$ in. to $\frac{3}{4}$ in. (10 mm to 19 mm), Inclusive



(a) Random Rounded Indications [See Note (1)]

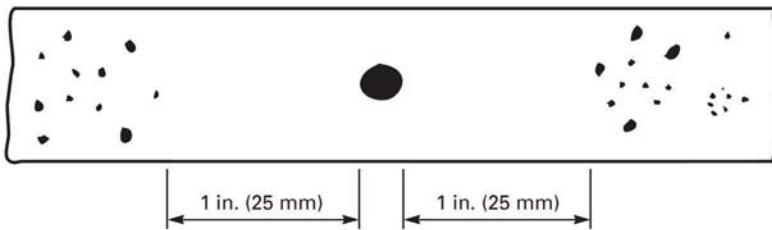

(b) Isolated Indication [See Note (2)]

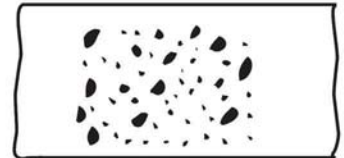

(c) Cluster

NOTES:

- (1) Typical concentration and size permitted in any 6 in. (150 mm) length of weld.
- (2) Maximum size per Table 4-1.

Figure 4-6
Charts for t Over $\frac{3}{4}$ in. to 2 in. (19 mm to 50 mm), Inclusive

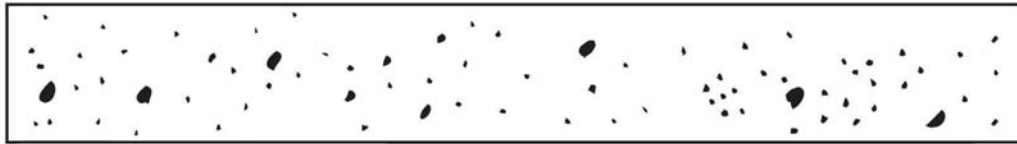

(a) Random Rounded Indications [See Note (1)]

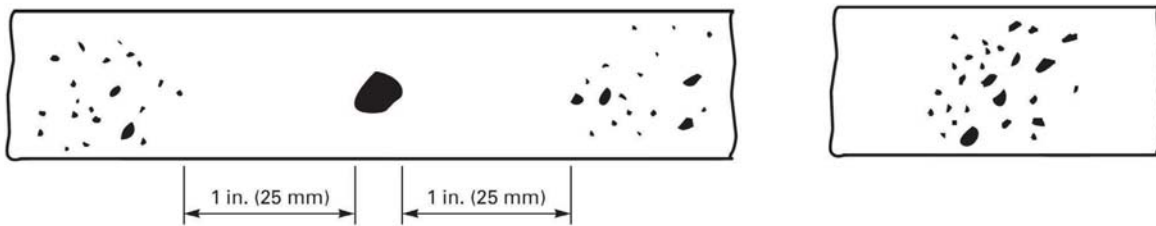

(b) Isolated Indication [See Note (2)]

(c) Cluster

NOTES:

(1) Typical concentration and size permitted in any 6 in. (150 mm) length of weld.

(2) Maximum size per Table 4-1.

Figure 4-7
Charts for t Over 2 in. to 4 in. (50 mm to 100 mm), Inclusive

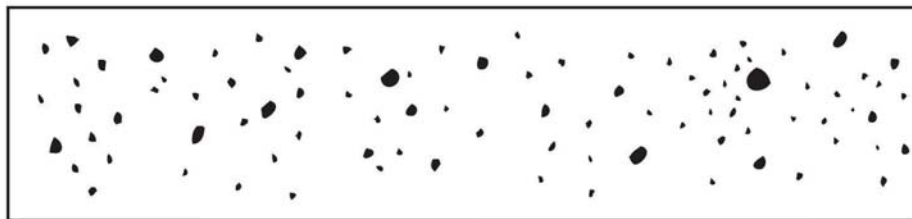

(a) Random Rounded Indications [See Note (1)]

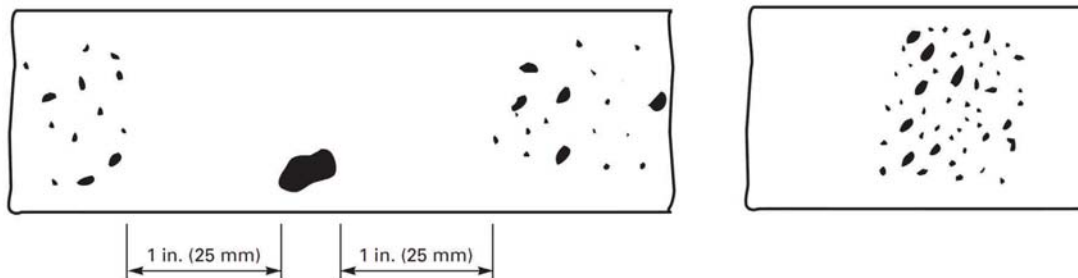

(b) Isolated Indication [See Note (2)]

(c) Cluster

NOTES:

(1) Typical concentration and size permitted in any 6 in. (150 mm) length of weld.

(2) Maximum size per Table 4-1.

Magnetic report: Contrast, Weld-Yoke

Report number:

Customer	Work location	Applus RTD Region Roosendaal Belder 8 4704RK ROOSENDAAL NL
	Contact person	Contact person mr. F de Krom

Project		
Client order number Sample Report Applus RTD workorder Sample Report	Project Sample Report Object Sample Report	Request number Sample Report Welding firm info Sample Report

Research		
Examination procedure MT 21201 Rev.25 Assessment procedure MT 21201 Rev.24	Examination standard ASME V article 7 Ed.2015 Assessment standard ASME VIII Div.1 app. 6 Ed.2015	Client examination specification - Client assessment specification -
Equipment EQ.001.MTYO.0070 Magnaflux 42V 14143 Calibration valid till	Lighting Daylight Illumination Intensity Equipment EQ.001.MTLM.0025 Voltcraft MS-1500 81006121 Calibration valid till	Test medium MR-76S Batch no 76SAS/1081A exp. Contrast medium MR-72 Batch no 72/1155A exp. Cleaner - Batch no - Demagnetisation No Reference point Zeropoint
Type of current AC Particle type Wet Type of magnetization Yoke technique	Light intensity [Lux] >1000	

Objects (1)												
Weld / object nr.	Object ID / drawing no	Object description	Material	Weld material	Weld method	Weld shape	Welder	Dia. / length (mm)	Nom. WT (mm)	Temp in °C	Surface condition	PWHT
1	Sample Report	Sample Report	C/Steel		-				10	20	Acceptable	No

Results of examination (1)						
Weld / object nr.	Object ID / drawing no	Magnetic deployment	Max. pole distance (mm)	Findings	Remarks	A/NA
1	Sample Report	Spray	150	No findings		A

Examination performed	Report approved
Examiner / interpreter	
Examiner	



Radiographic report: X-ray, Weld

Report number:

<i>Customer</i>	<i>Work location</i>	<i>Applus RTD</i> Applus RTD Delftweg 144 3046NC ROTTERDAM NL
	<i>Contact person</i>	<i>Contact person</i>

Project		
<i>Client order number</i> Example report <i>Applus RTD workorder</i>	<i>Project</i> - <i>Object</i> -	<i>Request number</i> - <i>Welding firm info</i> -

Research		
<i>Examination procedure</i> RT 21002 Rev.24 <i>Assessment procedure</i> RT 21034 Rev.0	<i>Examination standard</i> ASME V art 2 Ed.2013 <i>Assessment standard</i> ASME B31.3 table 341.3.2	<i>Client examination specification</i> - <i>Client assessment specification</i> -
<i>Equipment</i> EQ.001.RTRS.0116 Balteau Ceram35 300 dir Calibration valid till 01/08/2015	<i>Brand / type</i> AGFA D5 <i>Foil (front/back)</i> Pb 0,027mm <i>Screen</i>	<i>Inspection coverage</i> 100% <i># Films / cass.</i> 1 <i>Film development</i> Automatic 8 min @ 28°C

Objects (1)												
Weld / object nr.	Object ID / drawing no	Material	Weld method	Weld shape	Welder	Dia. / length (mm)	Nom. WT (mm)	PWHT	IQI Pos.	Setup	IQI	Req. Wire/hole
1	Example	C/Steel	GTAW	V	-	-	-	No	F	-	10 FE EN	-

Results of examination (3)													
Weld / object nr.	Film / exp.nr	Film dim. (cm)	Pen. WT (mm)	FFD / FOD (mm)	OFD (mm)	U (keV)	Rad. time (min)	I (mA)	Assessed Area	Density	Vis. wire / hole	Classification (Location_NA) (cm)	A/NA
1	1												A
	2												A
	3												A

<i>Examination performed</i> <i>Examiner</i> <i>Examiner</i>	<i>Report approved</i> <i>Filminterpreter</i>	<i>Customer approval</i>
--	--	--------------------------

Doc Ref : MT 19108
 Revision : 0
 Date : 20-12-2019
 Title : Magnetic testing procedure
 Client : Airpack Nederland B.V.

MAGNETIC TESTING PROCEDURE

Client : Airpack Nederland B.V.

Purpose of the examination : Magnetic particle inspection of welds.

Method : According to AWS D1.1 / D1.1M: 2015 (ASTM E709)

Issued by : Applus RTD BUA NL

Development – Revisions					
Revision no.	Prepared by	Date	Approved by	Date	Amendment details
0	Kevin Cocquyt	20-12-2019	Vincent Spieringhs	20-12-2019	

 Applus+ RTD ND Testing Kevin Cocquyt MT L3: N40004		 Applus+ RTD ND Testing V. Spieringhs			
Date	20-12-2019	Date	20-12-2019	Date	

Address
 Delftweg 144, 3046 NC Rotterdam
 P.O. Box 10065, 3004 AB Rotterdam
 The Netherlands
 www.ApplusRTD.com

This publication is the intellectual property of Applus+ RTD and may not be used in whole or in part for any purpose other than the business of Applus+ RTD and may not be used for the business of the recipient and may not be passed to any other person without the permission of Applus+ RTD.

Contents

1	Scope	3
2	Referenced documents	3
2.1	<i>Applus+ RTD documents</i>	3
2.2	<i>Codes and standards</i>	3
2.3	<i>Abbreviations</i>	3
3	General requirements	4
3.1	<i>Personnel qualifications</i>	4
3.2	<i>Safety precautions</i>	4
3.3	<i>Surface preparation</i>	4
3.4	<i>Surface temperature</i>	4
3.5	<i>Identification and datum position</i>	5
3.6	<i>Viewing conditions</i>	5
4	Equipment and consumables	5
4.1	<i>Yokes</i>	5
4.2	<i>Light meters</i>	5
4.3	<i>Examination consumables</i>	5
5	Examination	7
5.1	<i>Examination method</i>	7
5.2	<i>Direction of magnetization</i>	7
5.3	<i>Extent of examination</i>	7
5.4	<i>Demagnetization</i>	7
5.5	<i>Post examination cleaning</i>	7
6	Evaluation of indications	8
7	Acceptance standard	8
7.1	<i>Choice of acceptance criteria</i>	8
7.2	<i>Acceptance criteria</i>	9
8	Report	10

1 Scope

This procedure describes the method and acceptance criteria to be used for magnetic testing on structural steel skids with AC yoke magnetisation. To be performed in conformity with the requirements of;

- AWS D1.1/D1.1M:2015 (ASTM E709)

2 Referenced documents

2.1 *Applus+ RTD documents*

NL-10	Written practice for the Training, Qualification, Certification and Authorization of NDT Personnel
CP 31201	Verification procedure for electric magnetic yokes
CP 31203	Verification procedure for magnetic particle suspensions
CP 31210	Verification procedure of light intensity meters

2.2 *Codes and standards*

ISO 9712	Qualification and certification of NDT personnel
SNT TC 1A: 2006	Personnel qualification and certification in NDT
AWS D1.1/D1.1M:2015 (ASTM E709)	Magnetic particle Examination
AWS D1.1/D1.1M:2015	Acceptance standard for magnetic particle examination

2.3 *Abbreviations*

AC	Alternating Current
HSE	Health Safety and Environment
kg	kilogram
MT	Magnetic Testing
NDE	Non Destructive Examination
CJP	Complete Joint Penetration
°C	Temperature in degree Celsius
mm	Millimetre
<	Less than
≥	Greater than or equal to
CJP	Complete joint penetration
NA	Not applicable

3 General requirements

3.1 Personnel qualifications

NDE - personnel shall be qualified and certified in accordance with the valid version of Applus+ RTD written practice, which is in conformity with the recommended practice SNT-TC-1A and ISO 9712, level MT 2 as minimum.

3.2 Safety precautions

All applicable HSE laws and regulations and the HSE rules of our customers shall be observed at all times. Furthermore Applus+ RTD develops its own HSE rules.

In case of conflict between rules and regulations, the strictest will prevail.
Special consideration shall be given to:

- inflammable and/or volatile materials;
- contrast paint and aerosols as used in magnetic testing;
- Extra attention at magnetic testing on hot objects > 50°C.

Use of safety gloves and eye protection is recommended.

Note:

The vapors from the consumables may be hazardous. Proper ventilation shall be provided in the case of testing being performed in a confined space. At no time during examination, shall there be exposure to any naked flames or sparks due to the flammable nature of the materials.

The use of aerosol containers and dry powders in confined spaces is dangerous and therefore it is only permitted in accordance with the Applus+ RTD safety pocketbook "working in confined spaces".

3.3 Surface preparation

Prior to the magnetic examination the surface or weld surface plus at least 25 mm on both sides of the weld, shall be dry and free of dirt, grease, coating, preserving, scale, welding flux, weld spatter, oil and other matter, that could obscure surface openings or otherwise interfere with the examination.

Typical cleaning agents which may be used are detergents, organic solvents, de-scaling solutions, and paint removers. Degreasing and ultrasonic cleaning methods may also be used.

Surface preparation by grinding or machining may be necessary where surface irregularities could mask indications or produce false indications.

3.4 Surface temperature

The surface temperature of the part to be examined (only for the "wet method") shall be within the temperature range limitations set by the manufacturer of the particles.

3.4.1 High temperature

If the (surface) temperature is > 50°C suitable consumables shall be used.

3.5 Identification and datum position

The welds shall be identified in accordance with the client's requirements.

The marking of flaw indications on the tested component shall be considered necessary as the resultant indications found at the time of inspection cannot be considered permanent. The position of flaws shall be marked on the tested component by a method that will not affect the use of the component or prejudice any subsequent testing.

3.6 Viewing conditions

At all times during the examination with the non-fluorescent method, the light intensity at the surface to be examined shall be 1000 lux. as a minimum.

4 Equipment and consumables

4.1 Yokes

An AC magnet Yoke shall be used.

The lifting power shall be checked prior to examination, and shall be 4.5 kg as minimum at the maximum pole spacing that will be used.

The verification of the yoke shall be done once a year or whenever the yoke has been damaged or repaired, in accordance with procedure Applus+ RTD CP 31201.

A field indicator (e.g. Berthold field indicator) may be used, if necessary, to determine the field direction.

4.2 Light meters

Light meters shall be calibrated at least once a year (12 month period +/- 2 weeks) or whenever the meter has been repaired. If meters have not been in use for one year or more, calibration shall be done before being used.

The light meters have to be verified, according to Applus+ RTD verification procedure CP 31210.

4.3 Examination consumables

The examination consumables to be used must provide sufficient contrast with the surface to be examined. The examination medium shall be supplied by Applus+ RTD.

The preferred examination consumables are given on page 6; other products may be used after approval by Applus+ RTD level 3 specialist.

4.3.1 Black particles (wet method)

The magnetic particles, black and fluorescent, to be used in the examination shall meet the following requirements:

- Are oil or water suspended;
- The colour of the particles shall be such as to provide an adequate contrast with the surface being examined;
- The examination consumables shall be agitated (shaken) properly, as per manufacturers' recommendation, to ensure that the dispersion of particles is equal throughout the entire use of the containers contents.
- The test medium shall be applied by either flowing or spraying over the surface. The force of the application shall be such that weakly formed indications are not disturbed or removed.

Wet particles: MR Chemie:

<u>Type</u>	<u>Product</u>	<u>Temp. range</u>	<u>Suspension</u>
• MR 76 SAS	Magnetic testink (black)	+5° to +50°C	Oil based
• MR 221 GF	Magnetic testink (black)	+5° to +50°C	Water based

These wet particles have been tested by the manufacturer for conformity. Where necessary the examination medium will be tested in accordance with verification procedure Applus+ RTD CP 31203.

4.3.2 Contrast paint

If the contrast between the surface and the examination medium is too low, a very thin contrast paint layer shall be applied to the surface.

The preferred contrast paint is given below; other contrast paint may be used after approval by Applus+ RTD level 3 specialist.

<u>Type</u>	<u>Product</u>	<u>Temp. range</u>	<u>Suspension</u>
• MR 72	White contrast paint	+5° to +50°C	
• MR 721	White contrast paint	+5° to +50°C	Water based

5 Examination

5.1 Examination method

The magnetic particles used in an examination (wet or dry) shall be applied by the continuous method: The magnetizing current shall remain on while the examination medium is being applied and while excess of the examination medium will flow away, or the dry powder will be softly blown away. Following this, time shall be allowed for indications to form before removal of the magnetic field.

5.2 Direction of magnetization

To ensure detection of imperfections in all orientations, the area shall be magnetized in two directions approximately perpendicular to each other.

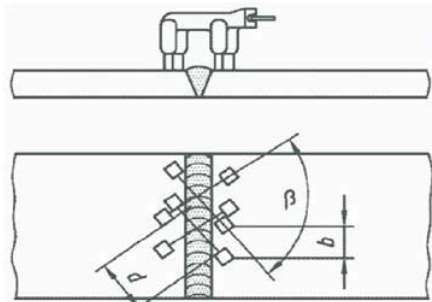

$d \geq 75$, $b \leq 2d$ and $\beta = 90^\circ$

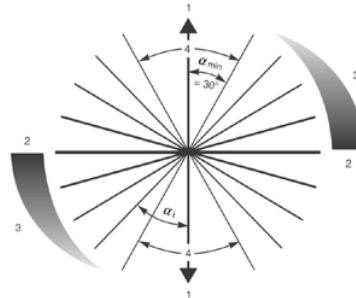

α = is the angle between the magnetic field and the direction of the imperfection α_{\min} = is the minimum angle for imperfection detection. α_1 = is an example of imperfection orientation.
1 = magnetic field direction, 2 = optimum sensitivity, 3 = reducing sensitivity and 4 = insufficient sensitivity

5.3 Extent of examination

The examination has to be executed in such a manner that there is sufficient overlap to ensure that 100% examination has been executed.

5.4 Demagnetization

The examined areas shall not be demagnetized after examination.

After testing with AC current, residual magnetization will normally be low and generally there is no need for demagnetization of the tested object.

5.5 Post examination cleaning

The examined areas shall not be cleaned after examination.

6 Evaluation of indications

The evaluation of indications shall be done during the magnetization.

An indication of an imperfection may be larger than the real imperfection. However the size of the indication will be the basis for the evaluation.

A linear indication is an indication (piping porosity), of which the length is larger than 3 times the width.

A rounded (non-linear) indication (porosity) is an indication of circular- and/or elliptical shape with a length equal to or less than 3 times its width.

Note:

Not all of the indications are relevant, because excessive surface roughness, etc. may cause similar indications. Any questionable indications shall be re-examined, possibly after surface improvement, to determine whether or not it is relevant.

7 Acceptance standard

7.1 Choice of acceptance criteria

The client shall provide the load condition and load direction before examination.

Required info:

Statically loaded or cyclically loaded.

Tensile stress during any load condition: Yes or No.

When the load condition is unknown the used acceptance shall be cyclically loaded with tensile stress.

7.2 Acceptance criteria

Acceptance according AWS D1.1: 2015 Claus 6. Table 6.1 and Clause 9, Table 9.6.

Discontinuity Category and Inspection Criteria	Table 6.1		Table 9.6
	Statically Loaded Nontubular Connections	Cyclically Loaded Nontubular Connections	Tubular Connections (All Loads)
1) Crack Prohibition <i>Any crack shall be unacceptable, regardless of size or location.</i>	X	X	X
(2) Weld/Base Metal Fusion <i>Complete fusion shall exist between adjacent layers of weld metal and between weld metal and base metal.</i>	X	X	X
(7) Undercut <i>A) For material less than 1 in [25 mm] thick, undercut shall not exceed 1/32 in [1 mm], with the following exception: undercut shall not exceed 1/16 in [2 mm] for any accumulated length up to 2 in [50 mm] in any 12 in [300 mm]. For material equal to or greater than 1 in [25 mm] thick, undercut shall not exceed 1/16 in [2 mm] for any length of weld.</i> <i>(B) In primary members, undercut shall be no more than 0.01 in [0.25 mm] deep when the weld is transverse to tensile stress under any design loading condition. Undercut shall be no more than 1/32 in [1 mm] deep for all other cases.</i>	X NA	NA X	NA X
(8) Porosity <i>(A) CJP groove welds in butt joints transverse to the direction of computed tensile stress shall have no visible piping porosity. For all other groove welds and for fillet welds, the sum of the visible piping porosity 1/32 in [1 mm] or greater in diameter shall not exceed 3/8 in [10 mm] in any linear inch of weld and shall not exceed 3/4 in [20 mm] in any 12 in [300 mm] length of weld.</i> <i>(B) The frequency of piping porosity in fillet welds shall not exceed one in each 4 in [100 mm] of weld length and the maximum diameter shall not exceed 3/32 in [2.5 mm]. Exception: for fillet welds connecting stiffeners to web, the sum of the diameters of piping porosity shall not exceed 3/8 in [10 mm] in any linear inch of weld and shall not exceed 3/4 in [20 mm] in any 12 in [300 mm] length of weld.</i> <i>(C) CJP groove welds in butt joints transverse to the direction of computed tensile stress shall have no piping porosity. For all other groove welds, the frequency of piping porosity shall not exceed one in 4 in [100 mm] of length and the maximum diameter shall not exceed 3/32 in [2.5 mm].</i>	X NA NA	NA X X	NA X X

Discontinuities 3, 4, 5 and 6 shall only be subject to visual inspection.

Discontinuities 2, 7 and 8 shall only be evaluated on length in case of an MPI indication and shall not be evaluated on other dimensions.

X shall be evaluated

NA shall not be evaluated

8 Report

For each magnetic examination carried out a report shall be written. Each report shall contain the following information as minimum:

- Procedure number and revision;
- Examination standard, acceptance standard;
- Client;
- Date of examination;
- Equipment used and type of current;
- Magnetic particles used incl. batch numbers (wet or dry);
- Object data and examined parts;
 - base material;
 - extent of examination
 - in case of welds type of weld, welding process and filler material;
 - heat treatment (if applicable);
 - thickness;
 - temperature of the object;
- Viewing conditions(light intensity);
- Drawing or record of all indications exceeding the acceptance standard;
 - All relevant indications shall be reported with as minimum the type, location and extent (length, diameter or aligned);
- Name operator(s) qualification and signature operator(s) who performed examination.

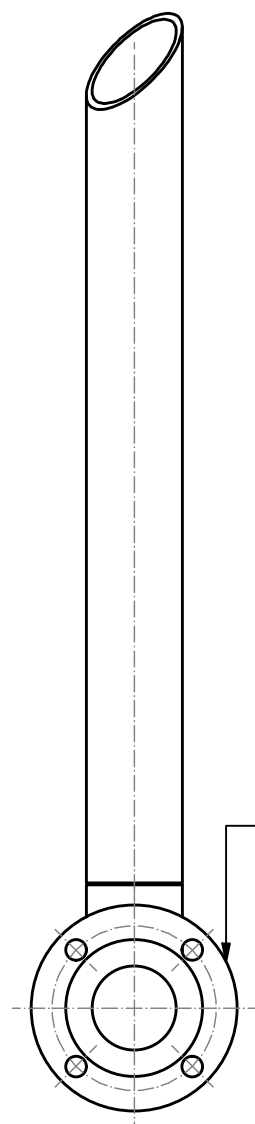
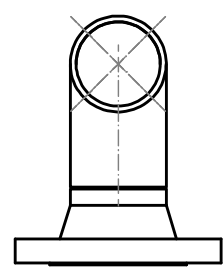
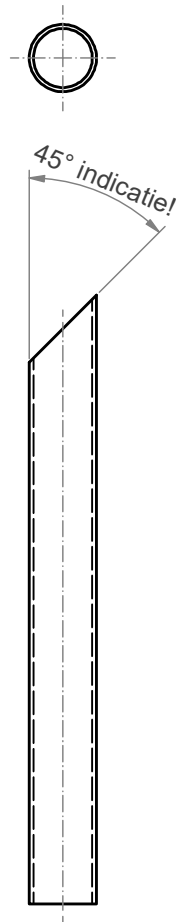

WN-Flange 3" Sch40 150# RF
A/SA105N
Charge no.:

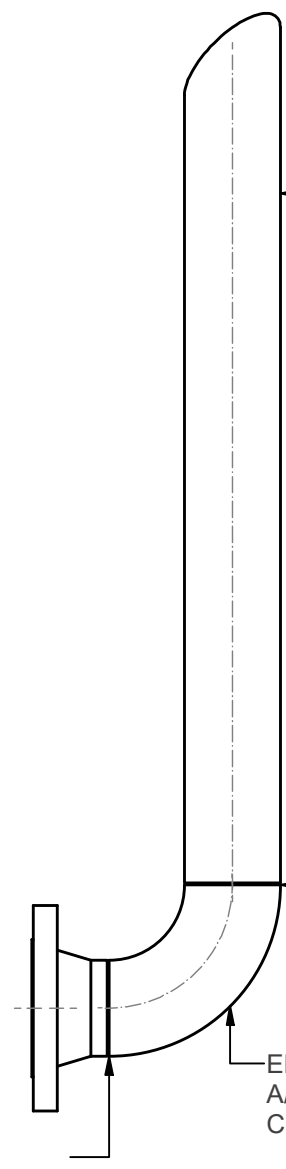

Pipe 3" ANSI Sch40
A/SA106-B
Charge no.:

Joint/Seam nr:
17811-COM-300-10-2

Elbow 90° LR 3" Sch40
A/SA234-WPB
Charge no.:

Joint/Seam nr:
17811-COM-300-10-1
X-ray report no.:

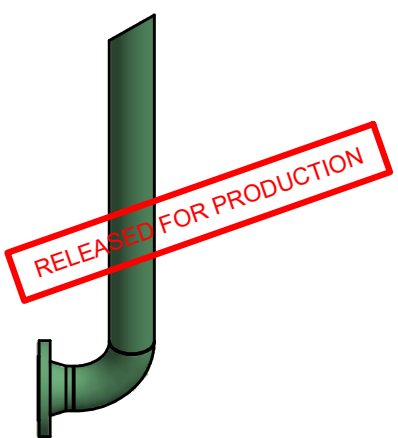
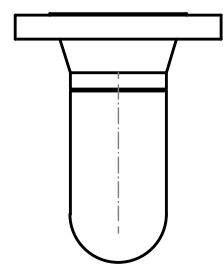

Subject		Air Compressor 20-C-7080		Projection		This drawing is owned by Airpack and shall not be printed or copied in any other way than with Airpacks PERMISSION
		Air Piping Cooler, PSV				
		2-2				
Client	Bushehr Petrochemical Company (BUPC)				MODIFICATIONS	
Client Ref.					Date	11-3-2022
Client Doc. No.					Drawn by	NP
		Airpack Nederland BV Groenewegje 25 4301 RN Zierikzee The Netherlands Telephone (31) (0) 111 - 415455 Telefax (31) (0) 111 - 413338 E-mail airpack@airpack.nl URL http://www.airpack.nl		Checked by	FvT	
				Plant Location	Iran, Onshore	
				Scale	--	
				Airpack Ref.	17811-COM	
				Drawing No.	17811-COM-300-10	
						Sheet 2 of 2

WN-Flange 1½" Sch80 150# RF
A/SA105N
Charge no.:

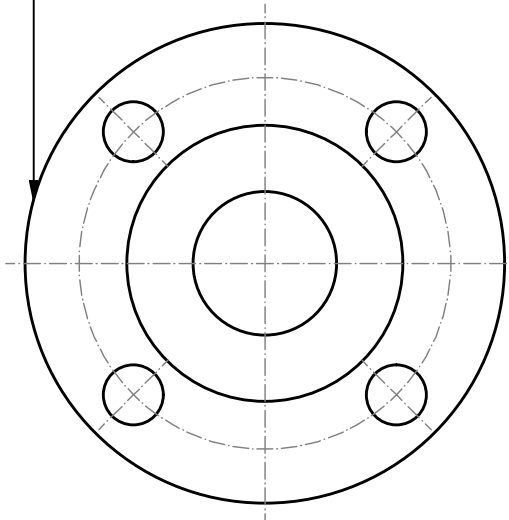

Pipe 1½" ANSI Sch80
A/SA106-B
Charge no.:

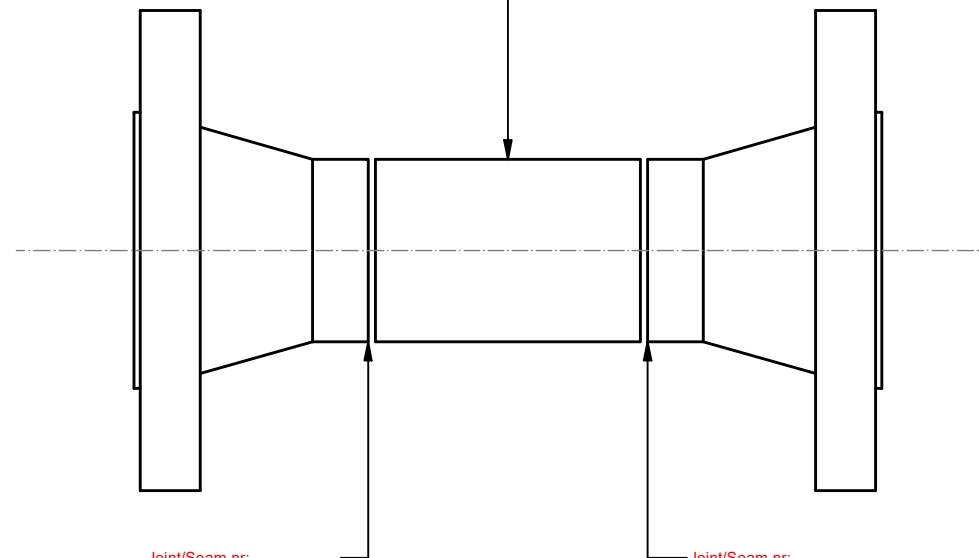

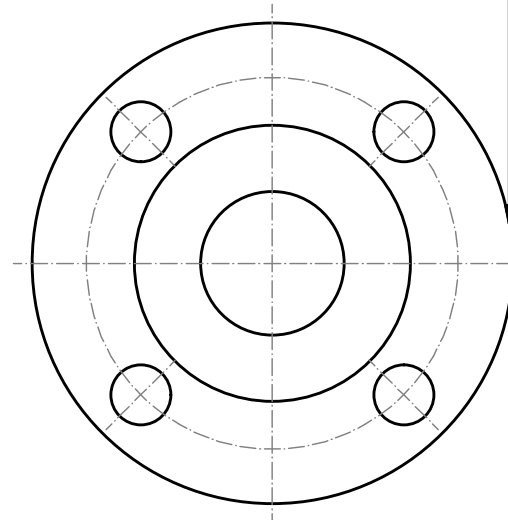

WN-Flange 1½" Sch80 150# RF
A/SA105N
Charge no.:

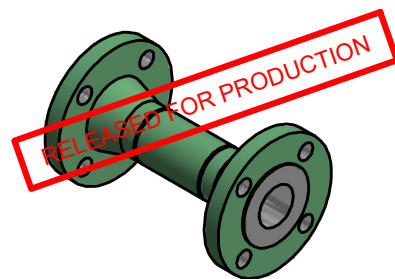

Joint/Seam nr:
17811-COM-300-11-1
X-ray report no.:

Joint/Seam nr:
17811-COM-300-11-2
X-ray report no.:

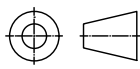

Subject		Air Compressor 20-C-7080		Projection	 This drawing is owned by Airpack and shall not be printed or copied in any other way than with Airpacks PERMISSION
		Air Piping Inlet, Outlet Cooling water			
		1-9			
Client	Bushehr Petrochemical Company (BUPC)			MODIFICATIONS	
Client Ref.		Date	11-3-2022		
Client Doc. No.		Drawn by	NP		
 Airpack Nederland BV Groenewegje 25 4301 RN Zierikzee The Netherlands Telephone (31) (0) 111 - 415455 Telefax (31) (0) 111 - 413338 E-mail airpack@airpack.nl URL http://www.airpack.nl		Checked by	FvT		
		Plant Location	Iran, Onshore		
		Scale	--		
		Airpack Ref.	17811-COM		
		Drawing No.	17811-COM-300-11		
				Sheet 2 of 2	

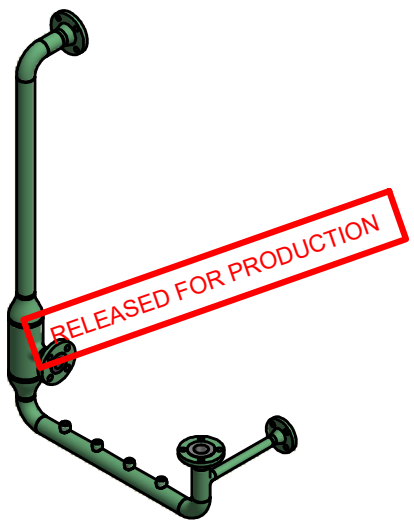
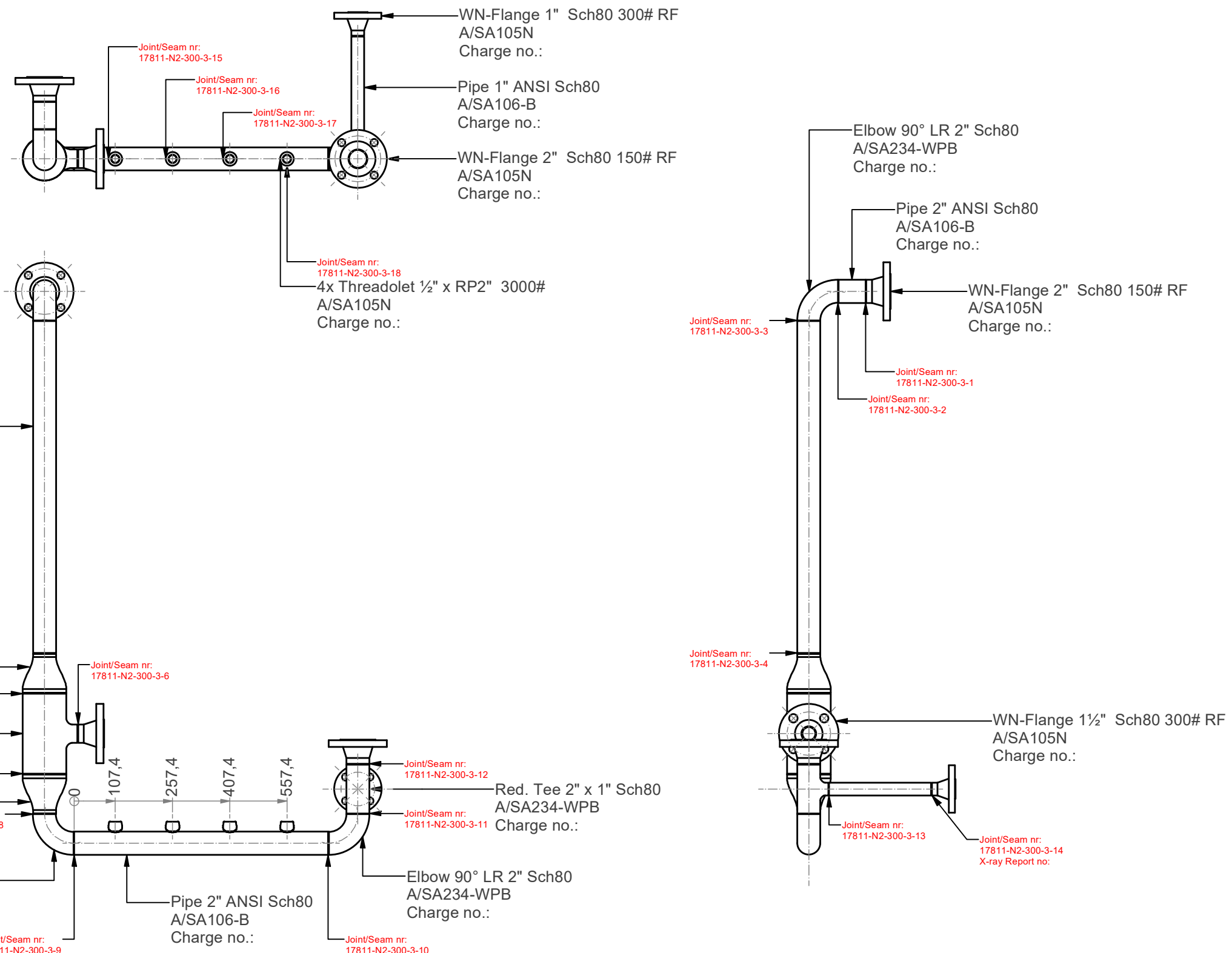

RELEASED FOR PRODUCTION

Subject Nitrogen Compressor 20-C-1002 N2 Piping inlet, outlet main 3-6		Projection 	This drawing is owned by Airpack and shall not be printed or copied in any other way than with Airpacks PERMISSION	
Client	Bushehr Petrochemical Company (BUPC)	MODIFICATIONS		
Client Ref.		Date	11-3-2022	
Client Doc. No.		Drawn by	NP	
		Airpack Nederland BV Groenewegje 25 4301 RN Zierikzee The Netherlands Telephone (31) (0) 111 - 415455 Telefax (31) (0) 111 - 413338 E-mail airpack@airpack.nl URL http://www.airpack.nl	Checked by	FvT
		Plant Location	Iran, Onshore	
		Scale	--	
		Airpack Ref.	17811-COM	
		Drawing No.	17811-N2-300-3	

WN-Flange 2" Sch80 300# RF
A/SA105N
Charge no.:

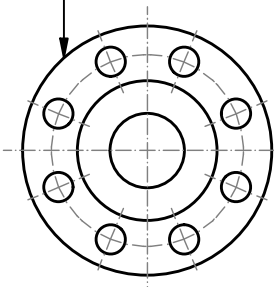

Pipe 2" ANSI Sch80
A/SA106-B
Charge no.:

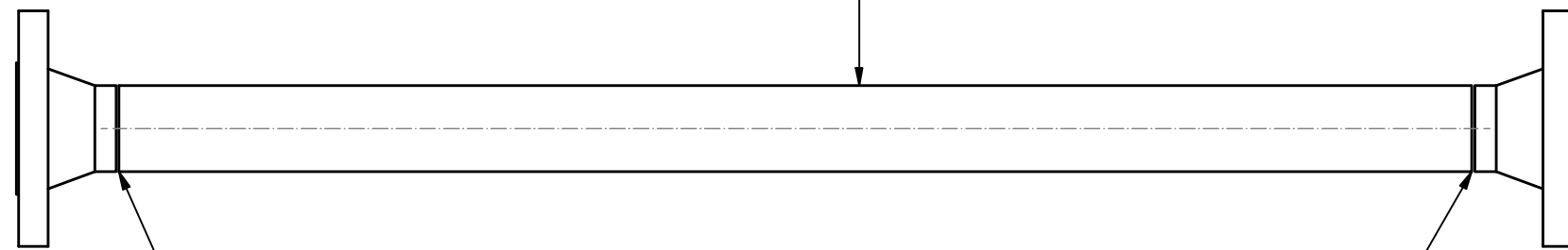

WN-Flange 2" Sch80 300# RF
A/SA105N
Charge no.:

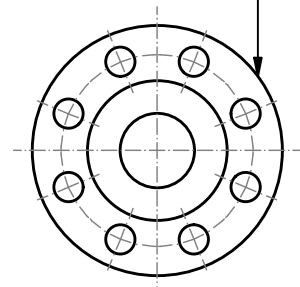

Joint/Seam nr:
17811-N2-300-6-1
X-ray report no:

Joint/Seam nr:
17811-N2-300-6-2
X-ray report no:



RELEASED FOR PRODUCTION

Subject Nitrogen Compressor 20-C-1002 N2 Piping inlet, outlet main 6-6		Projection 	This drawing is owned by Airpack and shall not be printed or copied in any other way than with Airpacks PERMISSION
Client	Bushehr Petrochemical Company (BUPC)	MODIFICATIONS	
Client Ref.		Date	11-3-2022
Client Doc. No.		Drawn by	NP
		Checked by	FvT
		Plant Location	Iran, Onshore
		Scale	--
		Airpack Ref.	17811-COM
		Drawing No.	17811-N2-300-6
Airpack Nederland BV Groenewegje 25 4301 RN Zierikzee The Netherlands Telephone (31) (0) 111 - 415455 Telefax (31) (0) 111 - 413338 E-mail airpack@airpack.nl URL http://www.airpack.nl		Sheet 2 of 2	

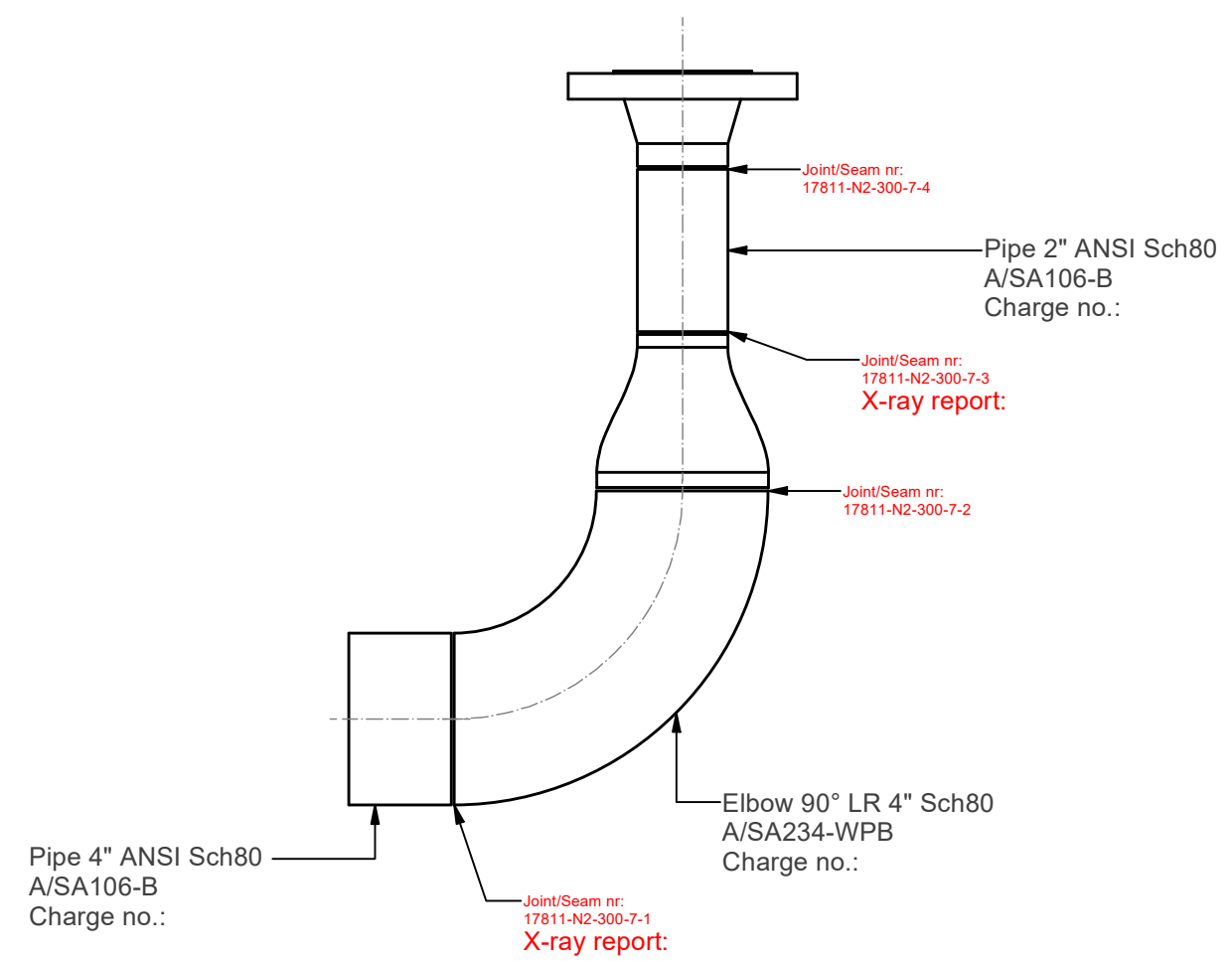
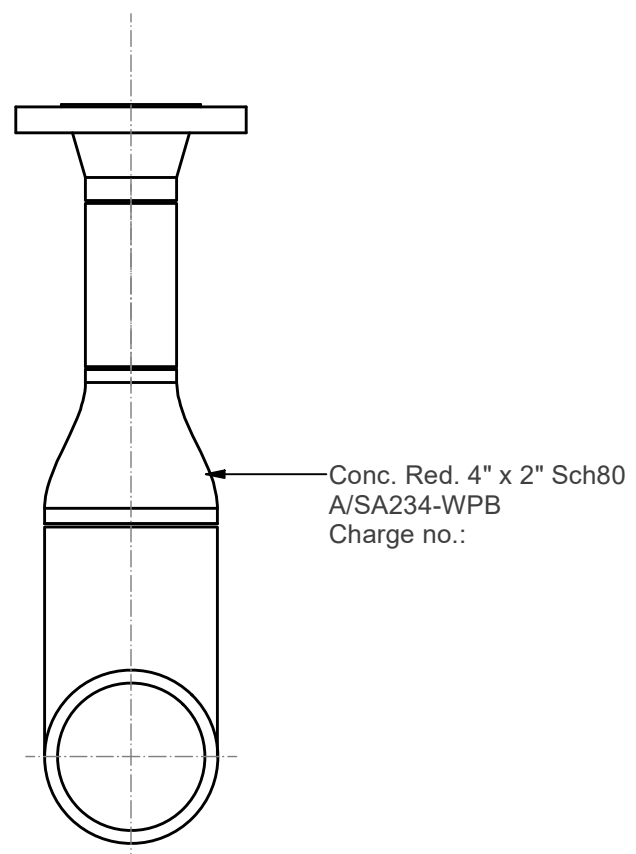
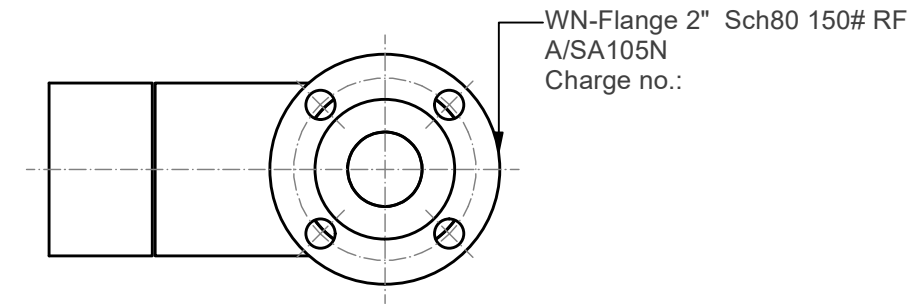

Subject Nitrogen Compressor 20-C-1002 N2 Piping inlet, outlet motor 1-4		Projection 	This drawing is owned by Airpack and shall not be printed or copied in any other way than with Airpacks PERMISSION
Client	Bushehr Petrochemical Company (BUPC)	MODIFICATIONS	
Client Ref.		Date	11-3-2022
Client Doc. No.		Drawn by	NP
		Checked by	FvT
		Plant Location	Iran, Onshore
		Scale	--
		Airpack Ref.	17811-COM
		Drawing No.	17811-N2-300-7
Airpack Nederland BV Groenewegje 25 4301 RN Zierikzee The Netherlands Telephone (31) (0) 111 - 415455 Telefax (31) (0) 111 - 413338 E-mail airpack@airpack.nl URL http://www.airpack.nl		Sheet 2 of 2	

WN-Flange 2" Sch80 300# RF
A/SA105N
Charge no.:

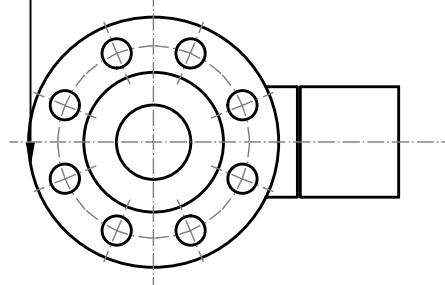

Pipe 2" ANSI Sch80
A/SA106-B
Charge no.:

Joint/Seam nr:
17811-N2-300-8-4

Joint/Seam nr:
17811-N2-300-8-3
X-ray report no:

Joint/Seam nr:
17811-N2-300-8-2

Elbow 90° LR 2½" Sch80
A/SA234-WPB
Charge no.:

Joint/Seam nr:
17811-N2-300-8-1
X-ray report no:

Pipe 2½" ANSI Sch80
A/SA106-B
Charge no.:

Conc. Red. 2½" x 2" Sch80 BW
A/SA234-WPB
Charge no.:

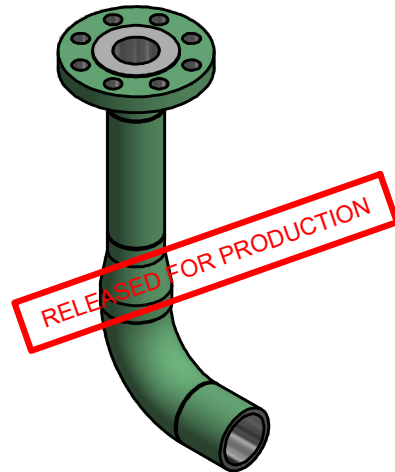
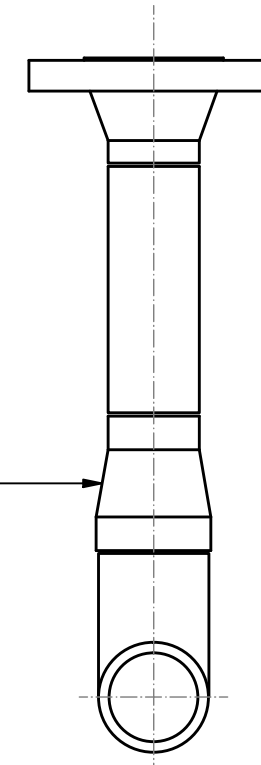

Subject Nitrogen Compressor 20-C-1002 N2 Piping inlet, outlet motor 2-4		Projection 	This drawing is owned by Airpack and shall not be printed or copied in any other way than with Airpacks PERMISSION	
Client	Bushehr Petrochemical Company (BUPC)	MODIFICATIONS		
Client Ref.		Date	11-3-2022	
Client Doc. No.		Drawn by	NP	
		Airpack Nederland BV Groenewegje 25 4301 RN Zierikzee The Netherlands Telephone (31) (0) 111 - 415455 Telefax (31) (0) 111 - 413338 E-mail airpack@airpack.nl URL http://www.airpack.nl	Checked by	FvT
		Plant Location	Iran, Onshore	
		Scale	--	
		Airpack Ref.	17811-COM	
		Drawing No.	17811-N2-300-8	

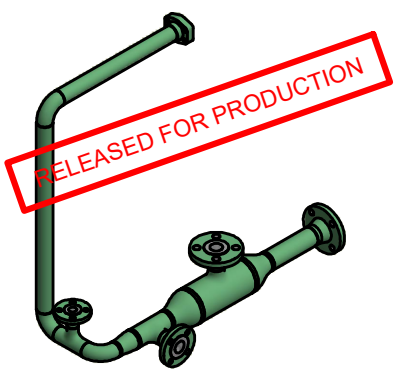
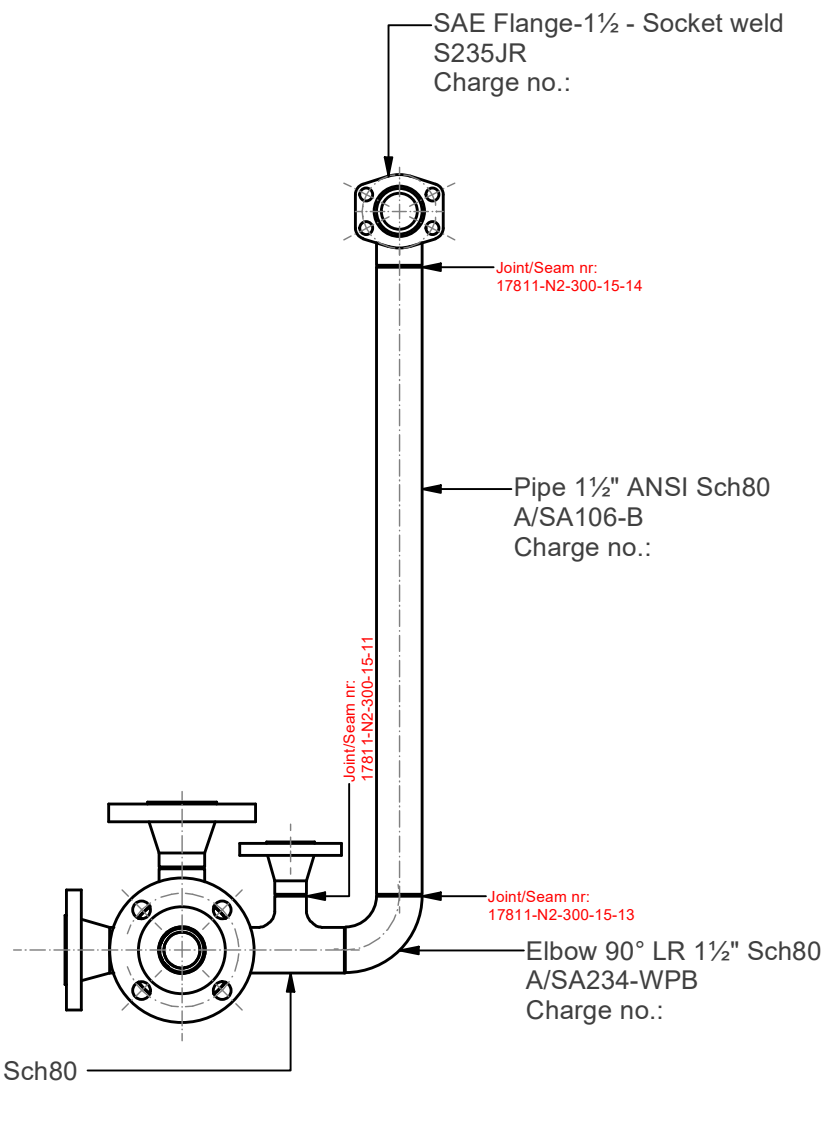
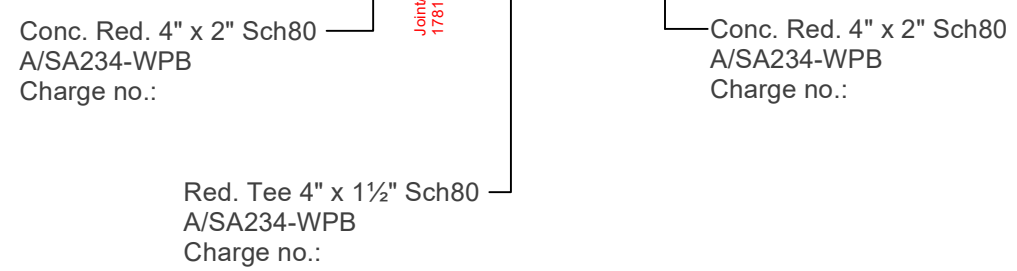
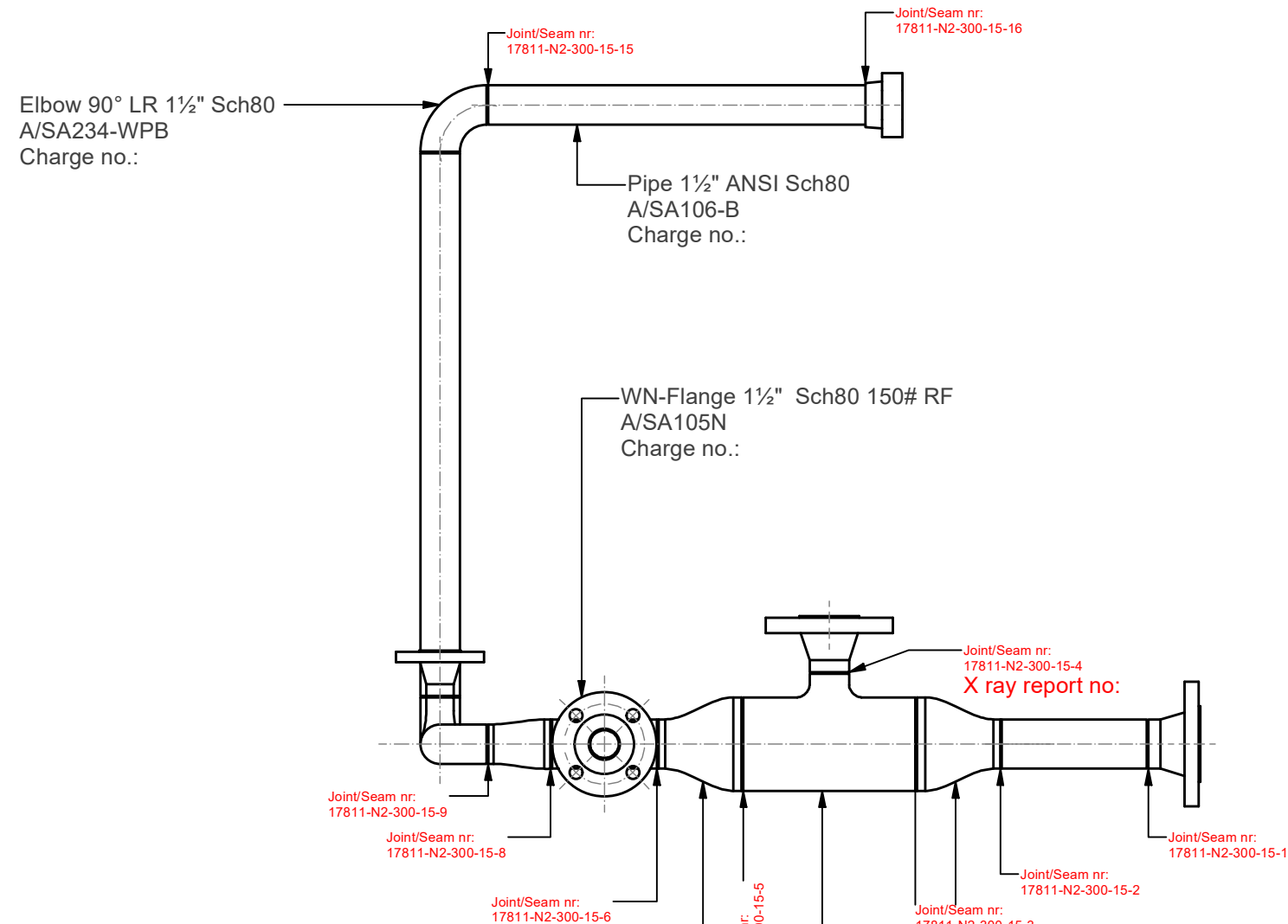
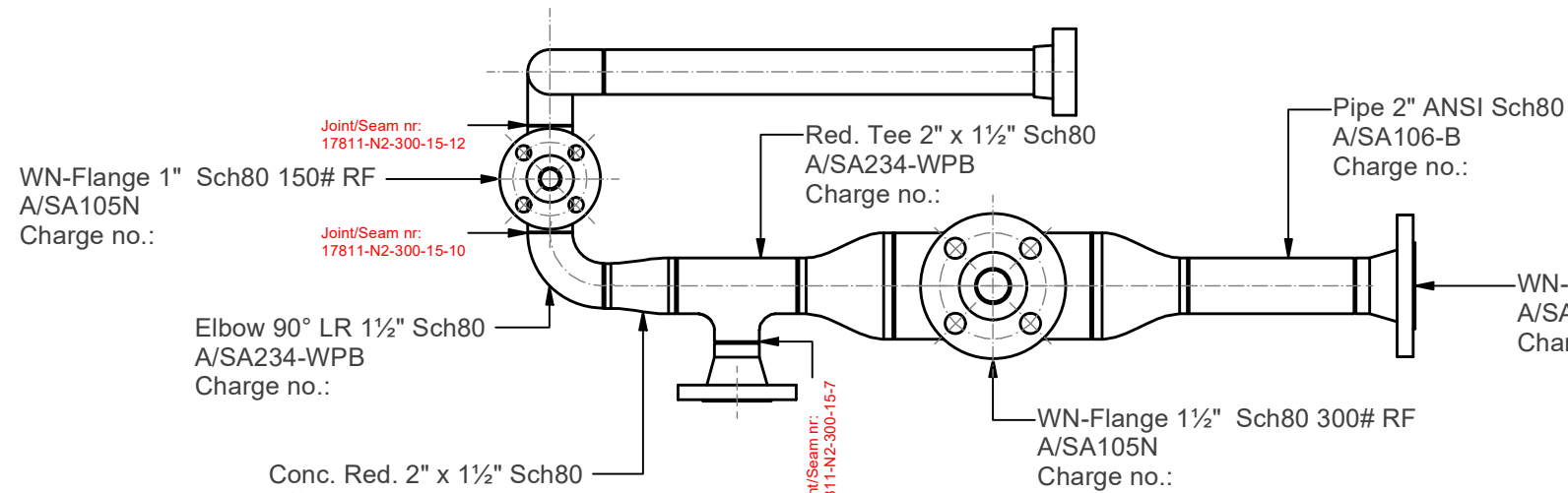

Subject Nitrogen Compressor 20-C-1002 N2 Piping Inlet, Outlet Cooling water 5-10		Projection 	This drawing is owned by Airpack and shall not be printed or copied in any other way than with Airpacks PERMISSION
Client Bushehr Petrochemical Company (BUPC)	MODIFICATIONS		Date 11-3-2022
Client Ref.	Drawn by NP		Checked by FvT
Client Doc. No.	Plant Location Iran, Onshore		Scale --
		Airpack Nederland BV Groenewegje 25 4301 RN Zierikzee The Netherlands Telephone (31) (0) 111 - 415455 Telefax (31) (0) 111 - 413338 E-mail airpack@airpack.nl URL http://www.airpack.nl	
		Airpack Ref. 17811-COM	Drawing No. 17811-N2-300-15

Elbow 90° LR 1½" Sch80
A/SA234-WPB
Charge no.:

Pipe 1½" ANSI Sch80
A/SA106-B
Charge no.:

SAE Flange-1½" - Socket weld
S235JR
Charge no.:

Joint/Seam nr:
17811-N2-300-16-1
X-ray report no:

Joint/Seam nr:
17811-N2-300-16-2

Joint/Seam nr:
17811-N2-300-16-3

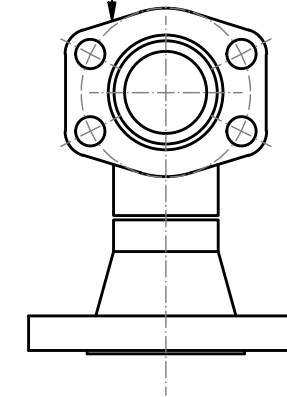
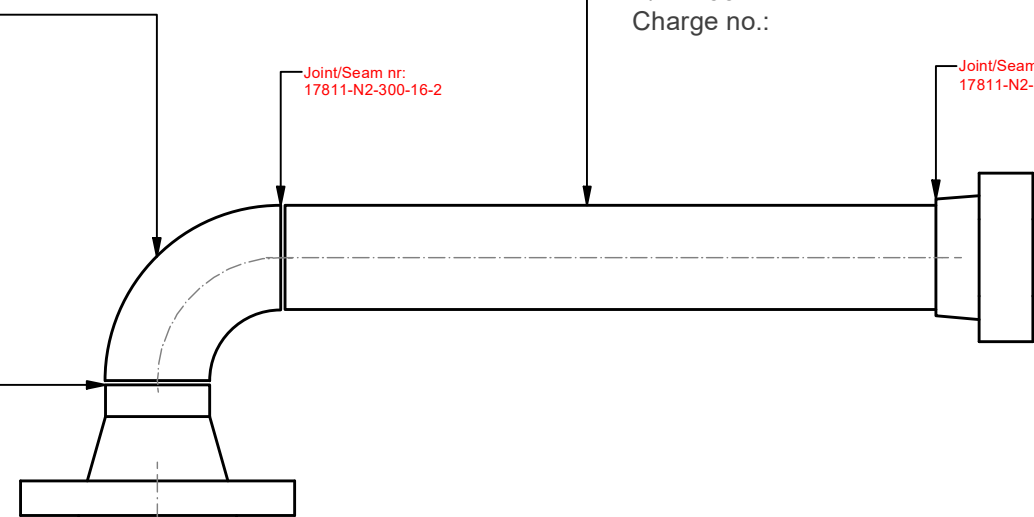

WN-Flange 1½" Sch80 150# RF
A/SA105N
Charge no.:

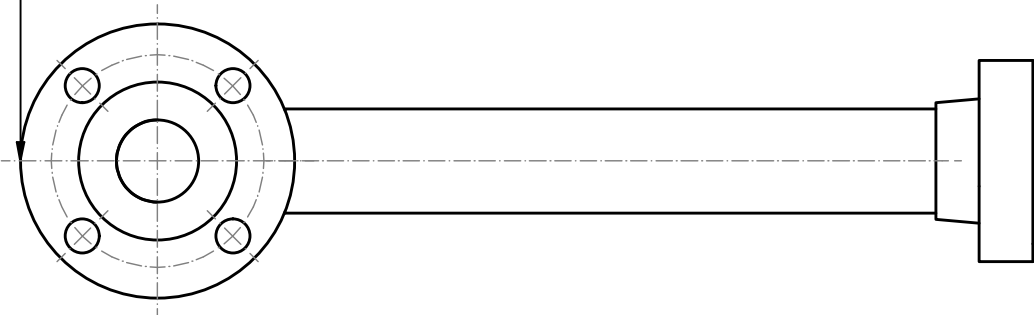

Subject		Nitrogen Compressor 20-C-1002		Projection		This drawing is owned by Airpack and shall not be printed or copied in any other way than with Airpacks PERMISSION	
		N2 Piping Inlet, Outlet Cooling water					
		6-10					
Client	Bushehr Petrochemical Company (BUPC)			MODIFICATIONS			
Client Ref.				Date	11/03/2022		
Client Doc. No.				Drawn by	NP		
				Checked by	FvT		
				Plant Location	Iran, Onshore		
				Scale	--		
				Airpack Ref.	17811-COM		
				Drawing No.	17811-N2-300-16		
Airpack Nederland BV Groenewegje 25 4301 RN Zierikzee The Netherlands Telephone (31) (0) 111 - 415455 Telefax (31) (0) 111 - 413338 E-mail airpack@airpack.nl URL http://www.airpack.nl				Sheet 2 of 2			

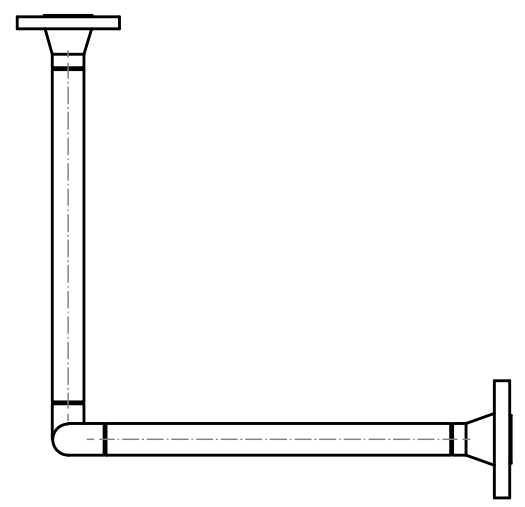
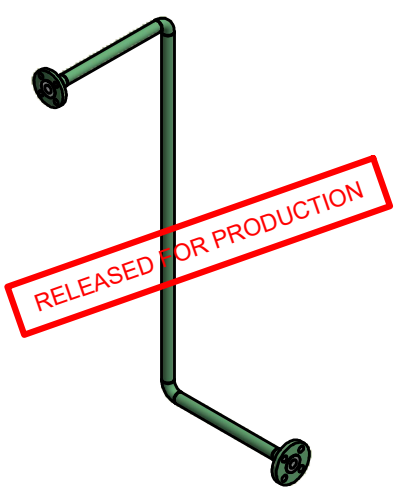
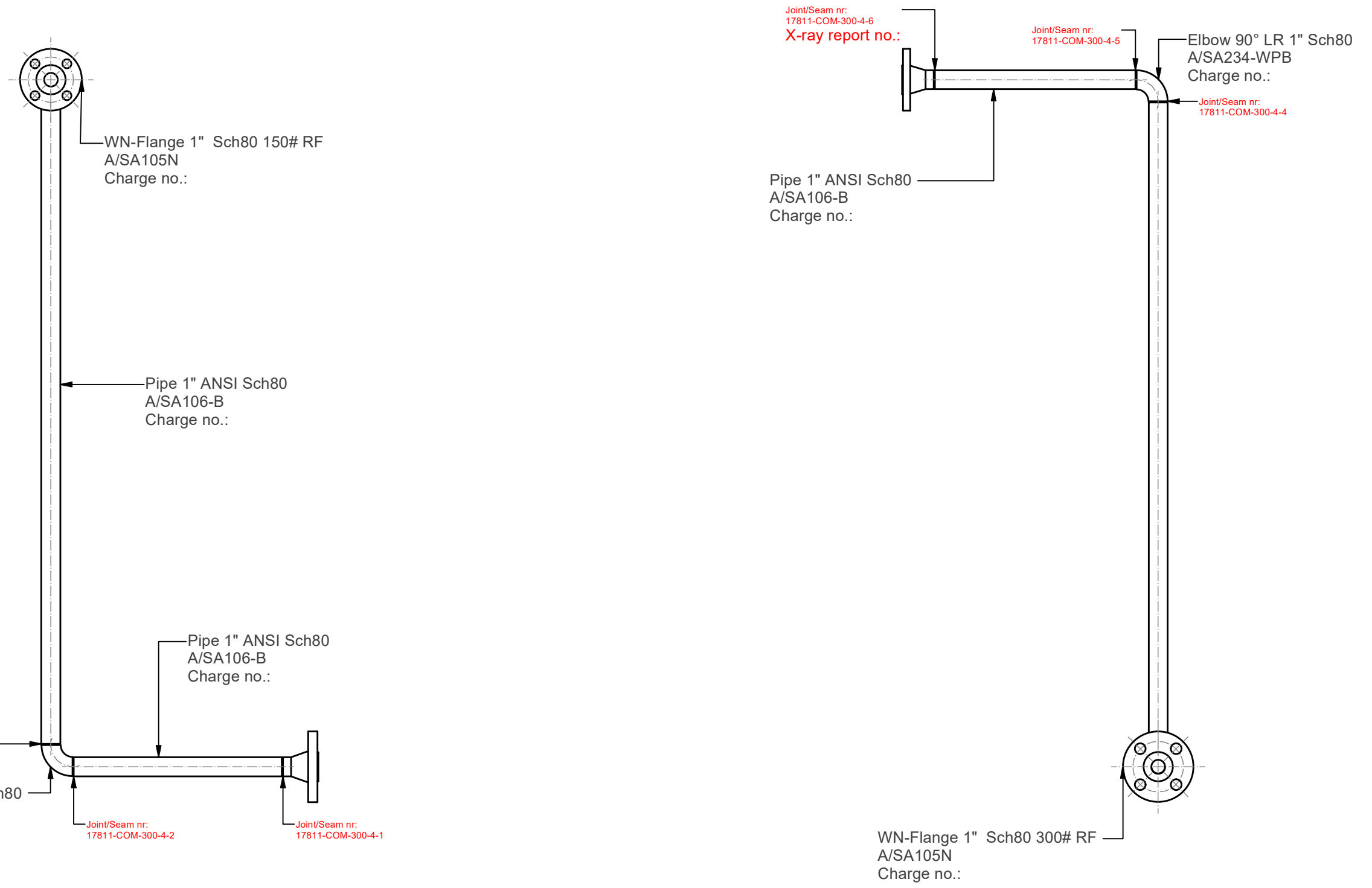

Subject		Air Compressor 20-C-7080		Projection		This drawing is owned by Airpack and shall not be printed or copied in any other way than with Airpacks PERMISSION
		Air Piping inlet, outlet main				
		4-6				
Client	Bushehr Petrochemical Company (BUPC)			MODIFICATIONS		
Client Ref.				Date	11-3-2022	
Client Doc. No.				Drawn by	NP	
				Checked by	FvT	
				Plant Location	Iran, Onshore	
				Scale	--	
				Airpack Ref.	17811-COM	
				Drawing No.	17811-COM-300-4	
Airpack Nederland BV Groenewegje 25 4301 RN Zierikzee The Netherlands Telephone (31) (0) 111 - 415455 Telefax (31) (0) 111 - 413338 E-mail airpack@airpack.nl URL http://www.airpack.nl				Sheet 2 of 2		

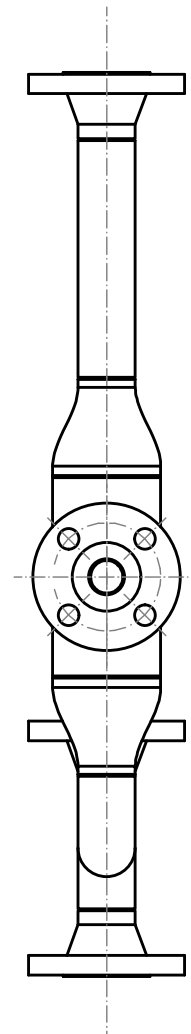
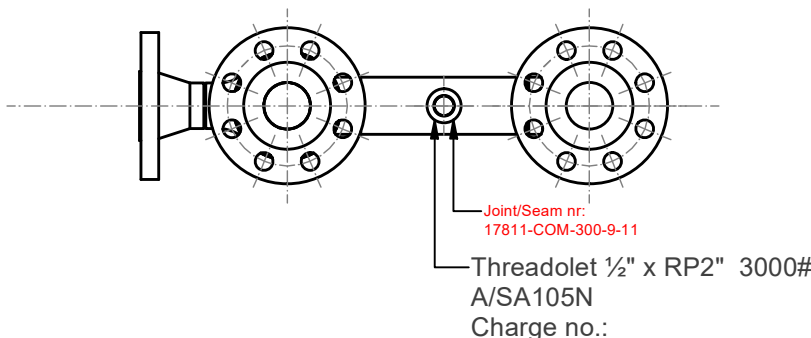

WN-Flange 2" Sch80 300# RF
A/SA105N
Charge no.:

WN-Flange 1 1/2" Sch80 300# RF
A/SA105N
Charge no.:

Elbow 90° LR 2" Sch80
A/SA234-WPB
Charge no.:

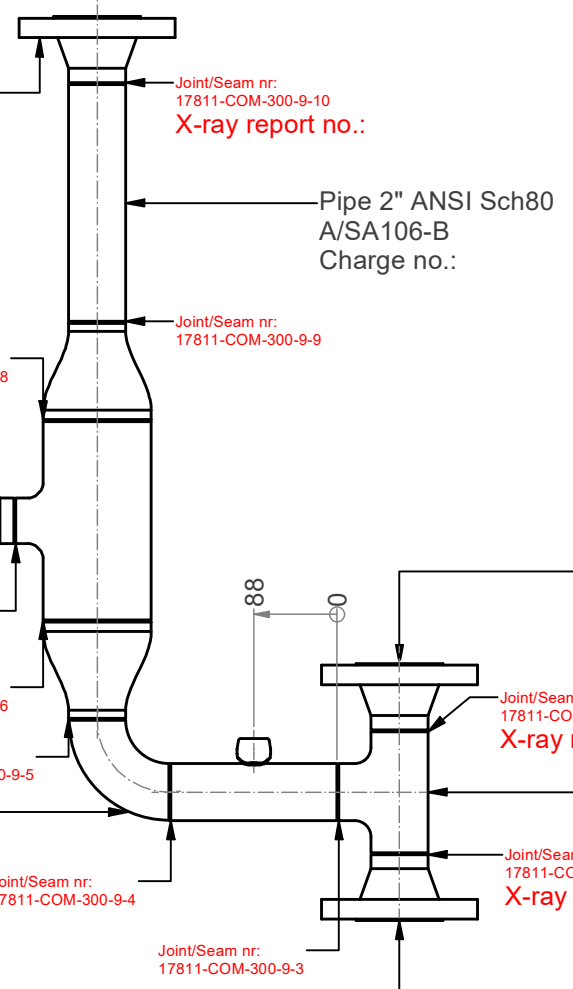

WN-Flange 2" Sch80 300# RF
A/SA105N
Charge no.:

Equal Tee 2" Sch80
A/SA234-WPB
Charge no.:

WN-Flange 2" Sch80 300# RF
A/SA105N
Charge no.:

Pipe 2" ANSI Sch80
A/SA106-B
Charge no.:

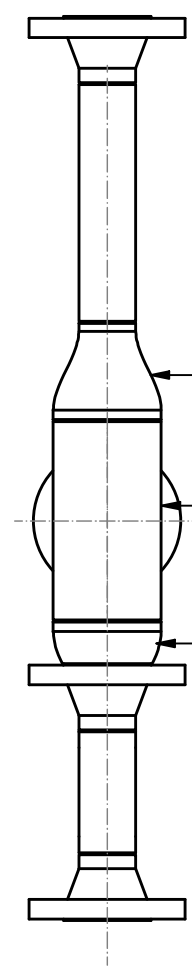
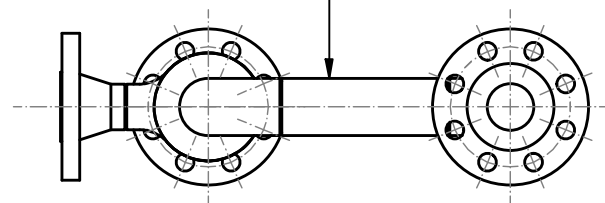

Conc. Red. 4" x 2" Sch80
A/SA234-WPB
Charge no.:

Red. Tee 4" x 1 1/2" Sch80
A/SA234-WPB
Charge no.:

Conc. Red. 4" x 2" Sch80
A/SA234-WPB
Charge no.:

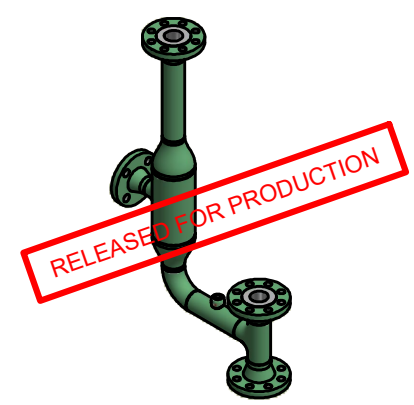

Subject		Air Compressor 20-C-7080		Projection		This drawing is owned by Airpack and shall not be printed or copied in any other way than with Airpacks PERMISSION	
		Air Piping Cooler, PSV					
		1-2					
Client	Bushehr Petrochemical Company (BUPC)			MODIFICATIONS			
Client Ref.				Date	11-3-2022		
Client Doc. No.				Drawn by	NP		
				Checked by	FvT		
				Plant Location	Iran, Onshore		
				Scale	--		
				Airpack Ref.	17811-COM		
				Drawing No.	17811-COM-300-9		
Airpack Nederland BV Groenewegje 25 4301 RN Zierikzee The Netherlands Telephone (31) (0) 111 - 415455 Telefax (31) (0) 111 - 413338 E-mail airpack@airpack.nl URL http://www.airpack.nl				Sheet 2 of 2			

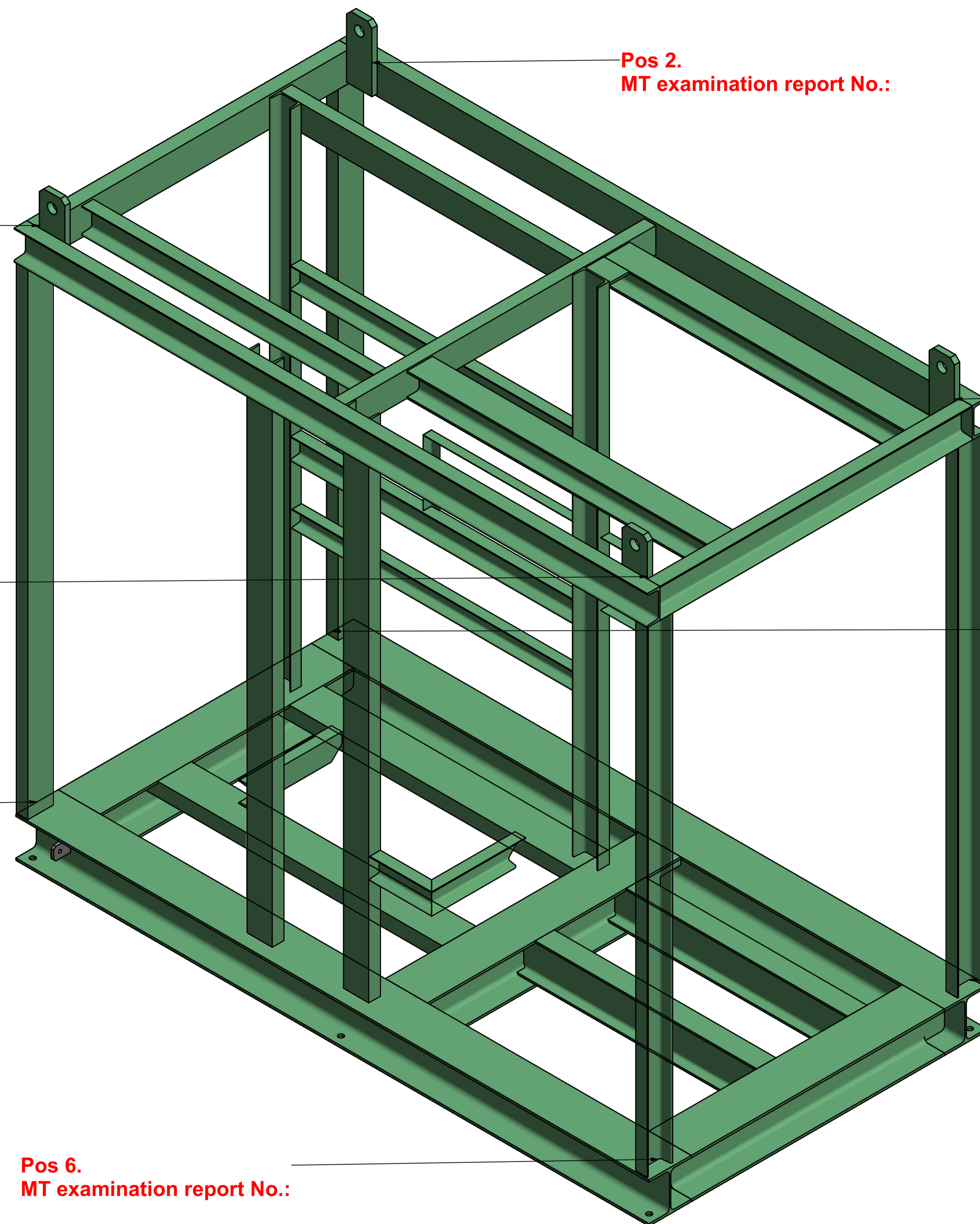

Pos 2.
MT examination report No.:

Pos 3.
MT examination report No.:

Pos 1.
MT examination report No.:



Pos 4.
MT examination report No.:

Pos 8.
MT examination report No.:

Pos 7.
MT examination report No.:

Pos 5.
MT examination report No.:

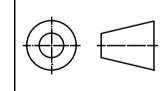
Pos 6.
MT examination report No.:

Subject		Instrument Air Compressor 20-C-7080		Projection		This drawing is owned by Airpack and shall not be printed or copied in any other way than with Airpack's PERMISSION	
		Construction only total					
Client		Bushehr Petrochemical Company (BUPC)		MODIFICATIONS			
Client Ref.		Date	01/03/2022	Drawn by	NP		
Client Doc. No.		Checked by	FVT	Plant Location	Iran, Onshore		
		Airpack Nederland BV Groenewegje 25 4321 RN Zierikzee The Netherlands Telephone (31) (0) 111 - 415455 E-mail: airpack@airpack.nl URL: http://www.airpack.nl		Scale	--	Airpack Ref.	17811-COM
		Drawing No.	17811-COM-101+103 MT	Sheet 3 of 3			

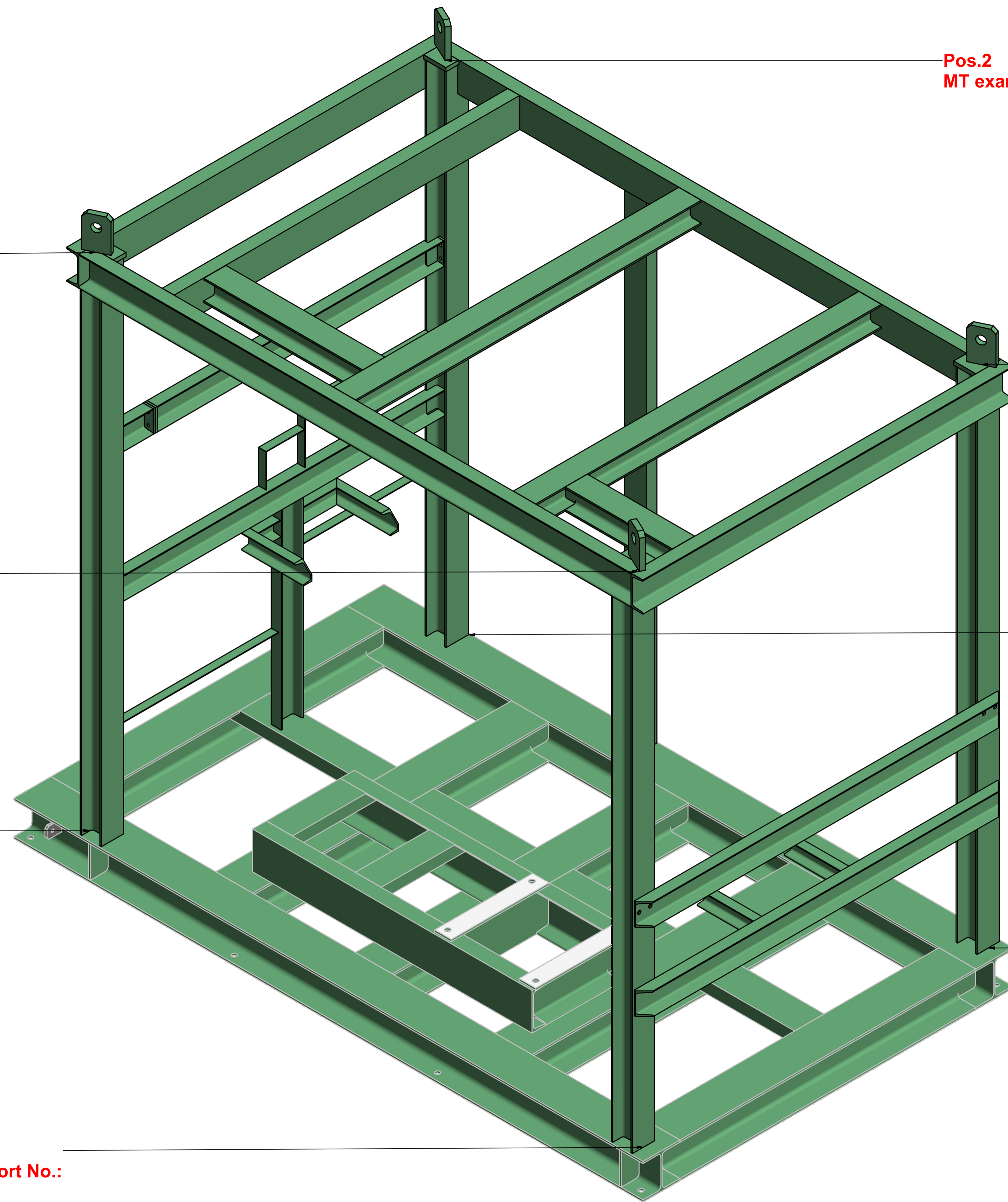

Pos.2
MT examination report No.:

Pos.3
MT examination report No.:

Pos.1
MT examination report No.:

Pos.4
MT examination report No.:

Pos.6
MT examination report No.:

Pos.7
MT examination report No.:

Pos.5
MT examination report No.:

Pos.8
MT examination report No.:

Subject Nitrogen Compressor 20-C-1002 Construction only total Support/Liftingframe		Projection 	This drawing is owned by Airpack and shall not be printed or copied in any other way than with Airpack's PERMISSION
Client Bushehr Petrochemical Company (BUPC)	Date 01/03/2022	MODIFICATIONS	
Client Ref.	Drawn by NP	Checked by FVT	
Client Doc. No.	Plant Location Iran, Onshore	Scale --	
 Airpack Nederland BV Groenewegje 25 4321 RN Zierikzee The Netherlands Telephone (31) (0) 111 - 415455 E-mail airpack@airpack.nl URL http://www.airpack.nl		Airpack Ref. 17811-COM	Drawing No. 17811-N2-101-103 MT