









OWNER:  شرکت مست و سویی گیس ایران (سهامی خاص) MC :  شرکت مست و سویی گیس ایران (سهامی خاص)	BUSHEHR PETROCHEMICAL COMPANY MEG PLANT							EPC CONTRACTOR:  Chagalesh-Enerchimi-Steam Joint Venture BUPC-MEG PLANT PROJECT	
	UCP/LCP/JB GENERAL ARRANGEMENT DRAWING & TERMINAL DETAILS FOR NITROGEN GAS BOOSTER INCL. BOM							 Contract No : 52-98/445	
Owner Document Number: 17811-07A	Project	Area	Phase	Unit	Dis.	Doc.	Seq.	Contract No : 52-98/445	
	BU	20	VD	303	IN	DWG	0039	Rev.:	Page
								01	1 of 8

UCP/LCP/JB GENERAL ARRANGEMENT DRAWING & TERMINAL DETAILS FOR NITROGEN GAS BOOSTER INCL. BOM

01	19/10/2021	For approval			HT	RB	KP	
00	24/11/2020	For approval			HT	RB	KP	
Rev.	Date	Purpose of Issue			Prepared	Checked	Approved	AC Code
							Class: 1	Phase: P

OWNER:  شرکت مست و سوی تومد ایرانیاان (سماهی نامیاان)	BUSHEHR PETROCHEMICAL COMPANY MEG PLANT						EPC CONTRACTOR:  Chagalesh-Enerchimi-Steam Joint Venture BUPC-MEG PLANT PROJECT		
	UCP/LCP/JB GENERAL ARRANGEMENT DRAWING & TERMINAL DETAILS FOR NITROGEN GAS BOOSTER INCL. BOM						 Netherlands		
MC :   شرکت مست و سوی تومد ایرانیاان (سماهی نامیاان)	Project	Area	Phase	Unit	Dis.	Doc.	Seq.	Contract No : 52-98/445	
Owner Document Number: 17811-07A	BU	20	VD	303	IN	DWG	0039	Rev.:	Page
								01	2 of 8

TABULATION OF REVISED PAGES

Page	D00	D01	D02	D03	D04
1.	X	X			
2.	X	X			
3.	X	X			
4.	X	X			
5.	X	X			
6.	X	X			
7.	X	X			
8.	X	X			
9.	X				
10.	X				
11.	X				
12.	X				
13.	X				
14.					
15.					
16.					
17.					
18.					
19.					
20.					
21.					
22.					
23.					
24.					
25.					
26.					
27.					
28.					
29.					
30.					
31.					
32.					
33.					
34.					

Page	D00	D01	D02	D03	D04
35.					
36.					
37.					
38.					
39.					
40.					
41.					
42.					
43.					
44.					
45.					
46.					
47.					
48.					
49.					
50.					
51.					
52.					
53.					
54.					
55.					
56.					
57.					
58.					
59.					
60.					
61.					
62.					
63.					
64.					
65.					
66.					
67.					

UCP-C1002-01

FRONT SIDE (OUTSIDE) VIEW

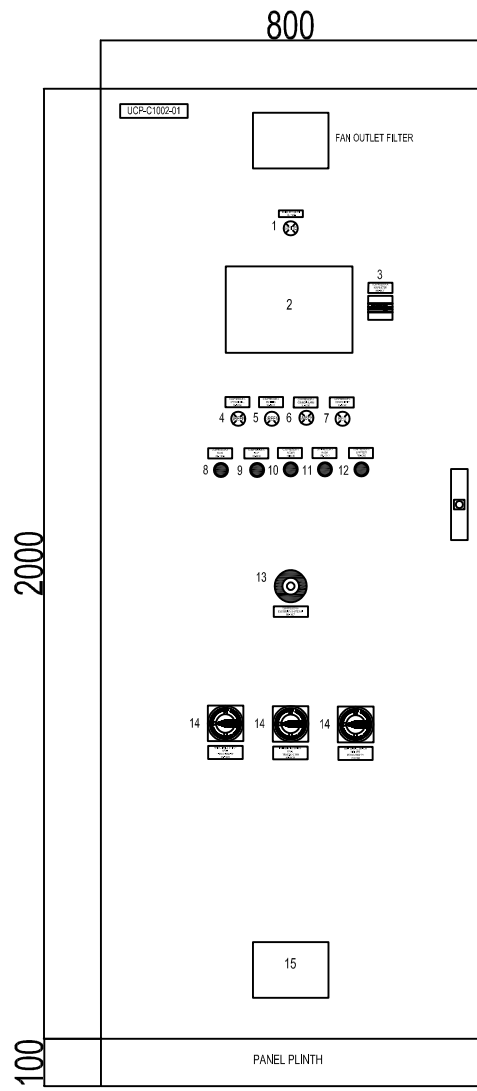

FRONT SIDE (INSIDE) VIEW

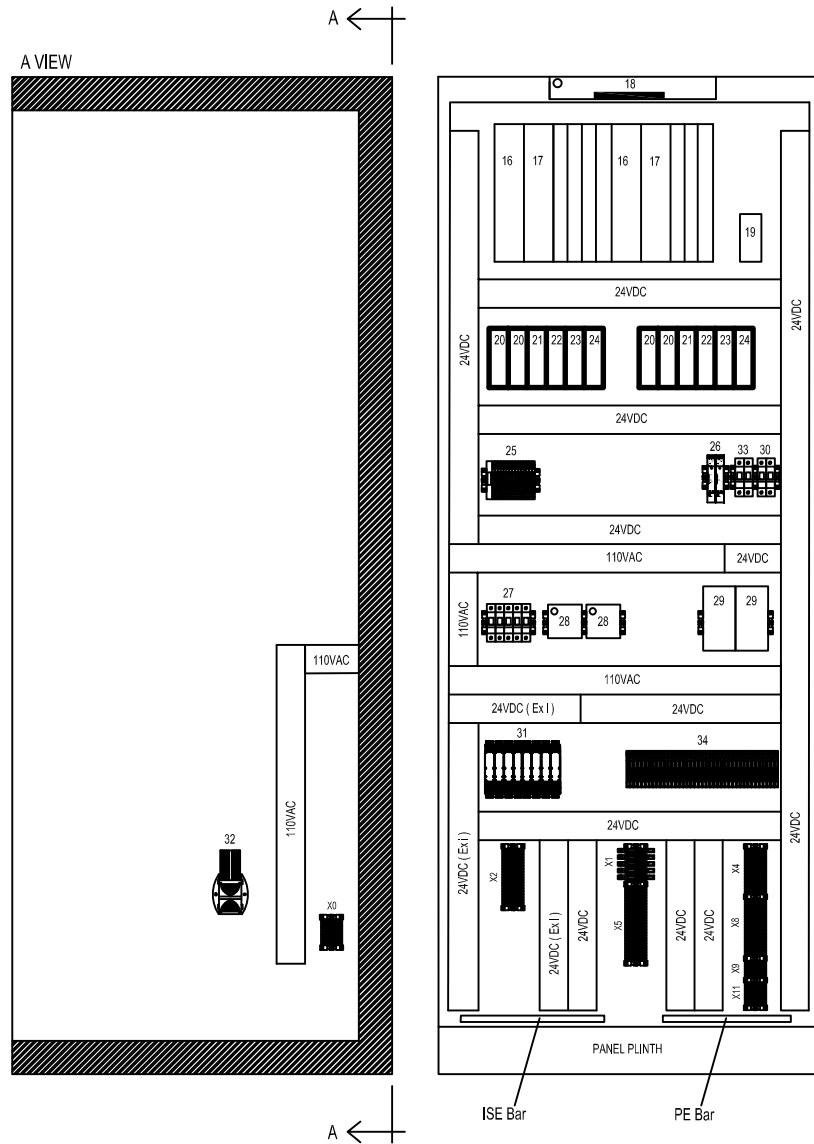

SIDE (OUTSIDE) VIEW

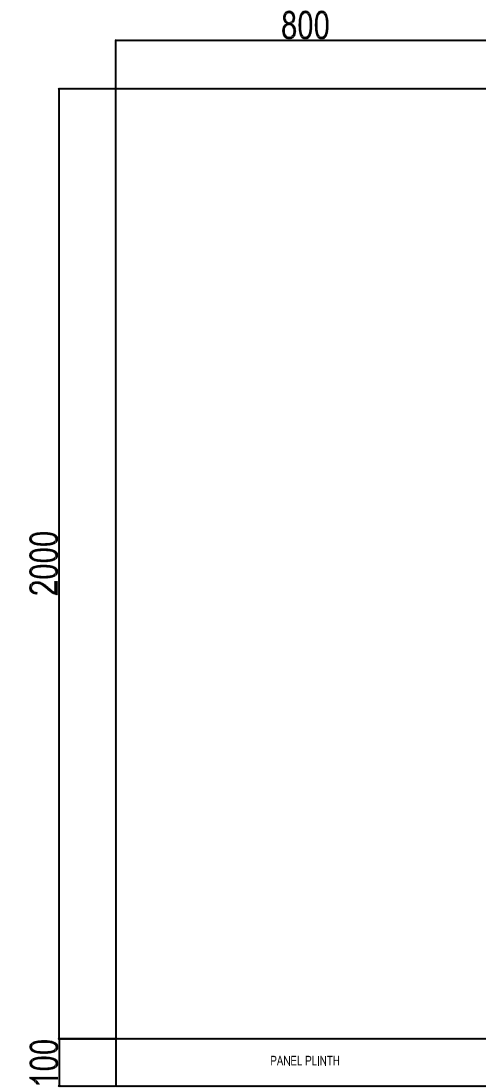

GENERAL NOTES

1. Panel material: Painted sheet steel (RAL7035)
2. Ingress protection: IP-42
3. Panel dimensions: 2100x800x800 mm
4. Area classification: Safe area
5. Drawing pocket will be included: (A3 format)

REFERENCE DRAWINGS	DWG.No.
xxxxxxx	xxxxxxx

Nameplate for UCP panel

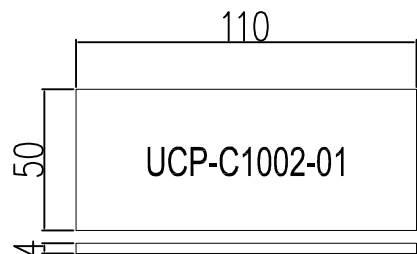

Nameplate for components on panel door
(Typical)

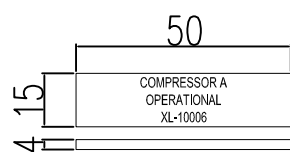

PLINTH FIXING HOLES

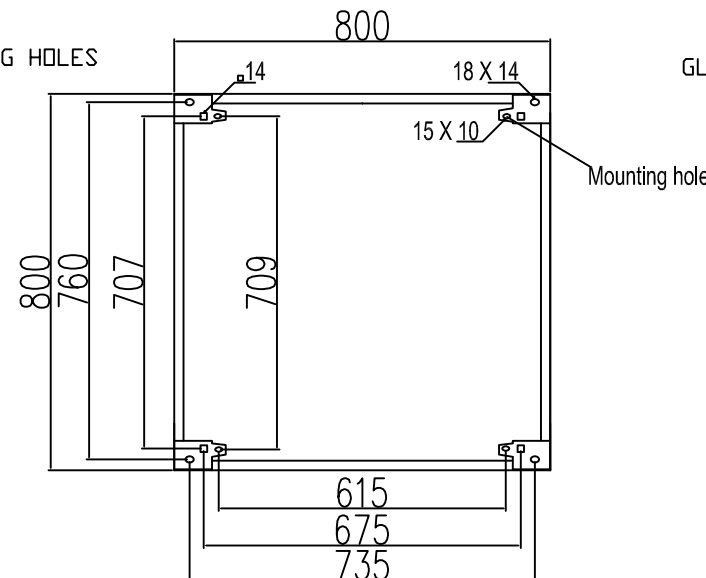

GLAND PLATE MOUNTING DETAILS

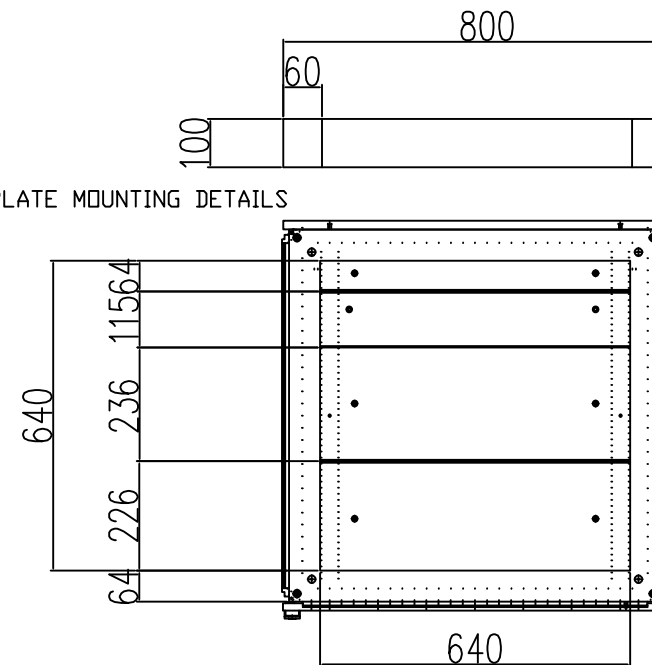

REV.	DATE	PURPOSE OF ISSUE (P.O.I.)	PREP.	CHKD.	APPR.	AC.
01	18/10/21	For approval	HT	RB	RB	-
00	24/11/20	For approval	HT	RB	RB	-

OWNER:	MC:	CONTRACTOR:

PROJECT: BUSHEHR PETROCHEMICAL COMPANY MEG PLANT

DRAWING TITLE: 17811-07A
UCP/UCP/18 GENERAL ARRANGEMENT DRAWING & TERMINAL DETAILS FOR NITROGEN GAS

CONTRACT NO.	SCALE	SIZE	CLASS	PHASE
52-28/445	XX	A0	1	P

DOCUMENT NO.	PROJECT	AREA	PHASE	MRQ No.	DIS.	DOC.	SEQ.	SHEET	REV. NO.
00-20-10-303-0-000-000								6	01

JNDX-C1002-01

FRONT SIDE (OUTSIDE) VIEW

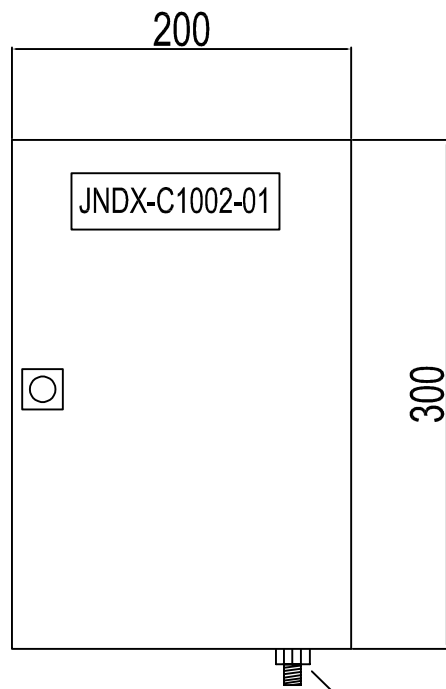

EARTHING
BOSS
M10

FRONT SIDE (INSIDE) VIEW

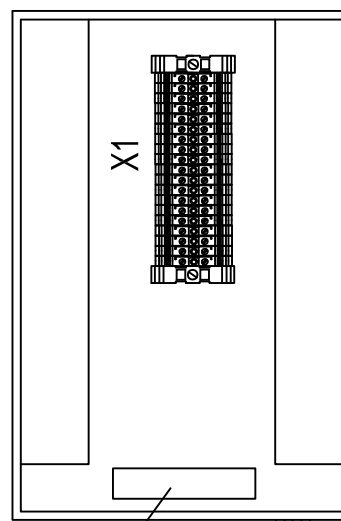

ISE Bar

EARTHING
BOSS
M10

SIDE (OUTSIDE) VIEW

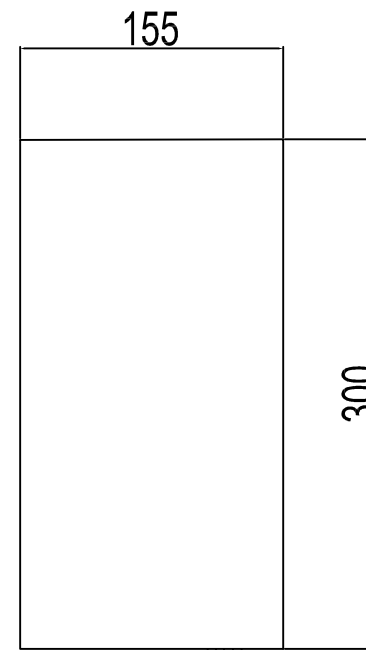

EARTHING
BOSS
M10

BOTTOM VIEW

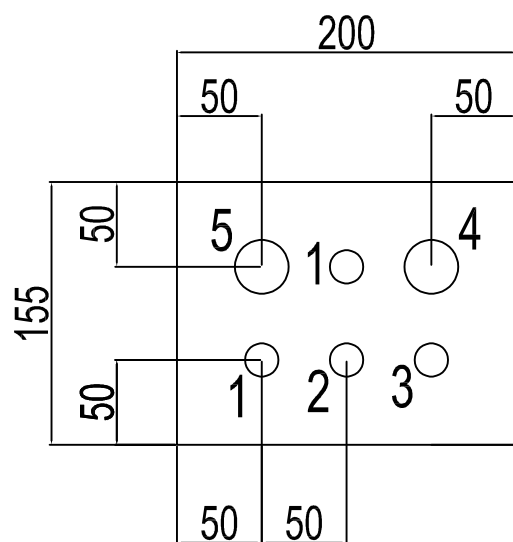

- 1 = Solenoid cable - M20
- 2 = Spare plug - M20
- 3 = Breather / Drain - M20
- 4 = Solenoid multipair cable - M32
- 5 = Spare plug - M32

GLAND ENTRY DETAILS

- M20: 1x (Breather)
- M20: 3x
- M32: 2x

Nameplate for junction box

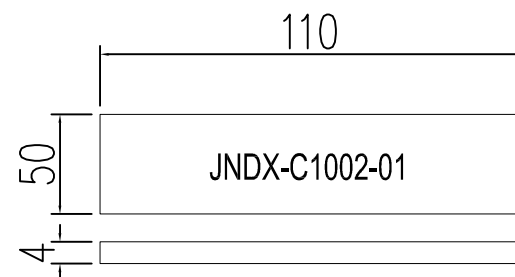

GENERAL NOTES



1. Panel material: SS316
2. Ingress protection: IP-65
3. Panel dimensions: 200x300x155 mm
4. Area classification: Eex 'e'
(RAL 6021) Green
5. All spare holes are plugged with certified plugs

REFERENCE DRAWINGS

xxxxxxx

DWG.No.

xxxxxxx

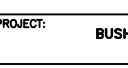
01	18/10/21	For approval	HT	RB	RB	-
00	24/11/20	For approval	HT	RB	RB	-
REV.	DATE	PURPOSE OF ISSUE (P.O.I.)	PREP.	CHKD.	APPR.	AC.
OWNER:			MC:		CONTRACTOR:	
						
PROJECT: BUSHEHR PETROCHEMICAL COMPANY MEG PLANT						
DRAWING TITLE: 17811-07A						
UCP/LCP/IB GENERAL ARRANGEMENT DRAWING & TERMINAL DETAILS FOR NITROGEN GAS						
CONTRACT NO.	SCALE	SIZE	CLASS	PHASE		
52-28/445	XX	A0	1	P		
DOCUMENT NO.	PROJECT	AREA	PHASE	MRQ No.	DIS.	DOC. SEQ.
OWNER DOC. NO.	PROJECT	AREA	PHASE	MRQ No.	DIS.	DOC. SEQ.
BU-20-VD-303-IN-000-00	BU-20-VD-303-IN-DWG-0039					
						3 OF 6
						01

JIAX-C1002-01

FRONT SIDE (OUTSIDE) VIEW

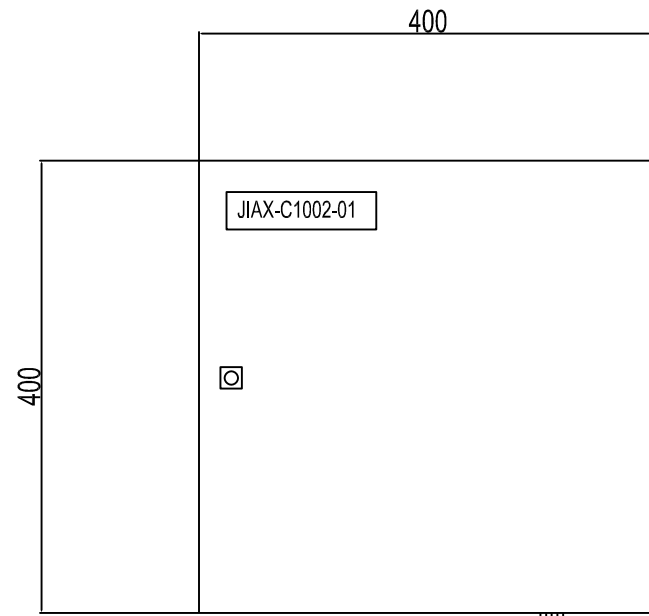

EARTHING BOSS M10

FRONT SIDE (INSIDE) VIEW

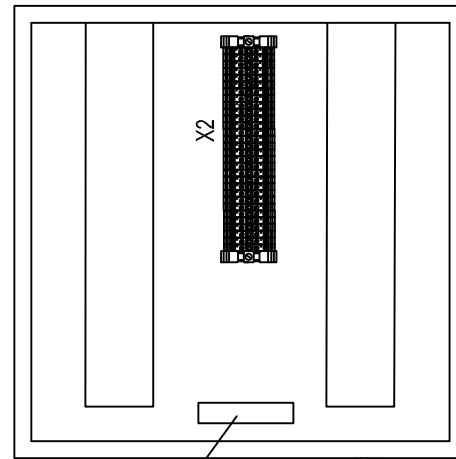

PE Bar

EARTHING BOSS M10

SIDE (OUTSIDE) VIEW

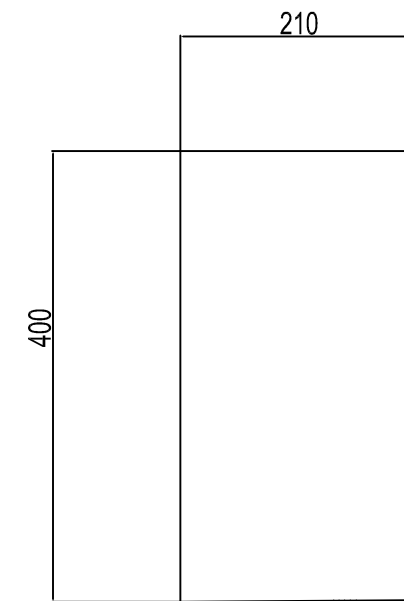

EARTHING BOSS M10

BOTTOM VIEW

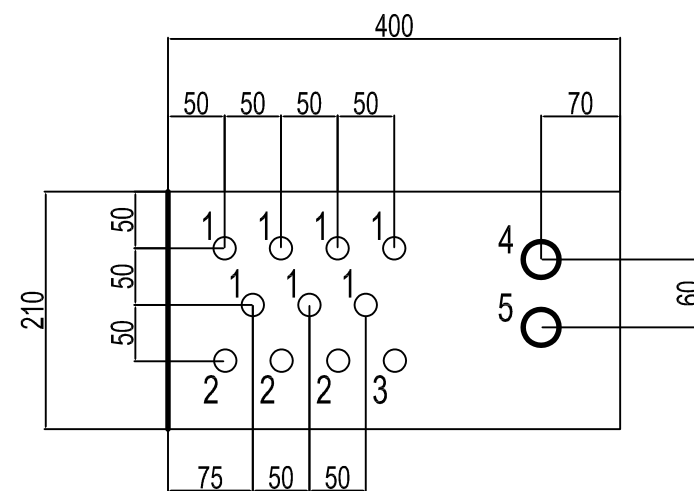

GLAND ENTRY DETAILS

- M20: 1x (Breather)
- M20: 10x
- M32: 2x

- 1 = Transmitter cable - M20
- 2 = Spare plug - M20
- 3 = Breather / Drain - M20
- 4 = Transmitter multipair cable - M32
- 5 = Spare plug - M32

Nameplate for junction box

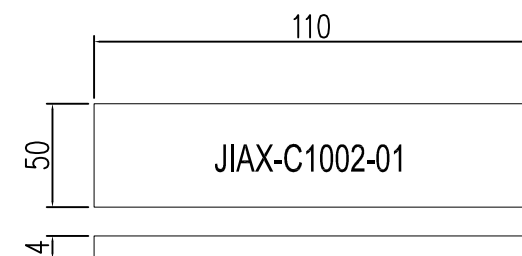

GENERAL NOTES

1. Panel material: SS316
2. Ingress protection: IP-65
3. Panel dimensions: 400x400x210 mm
4. Area classification: Eex 'i' (RAL 5015) Blue
5. All spare holes are plugged with certified plugs

REFERENCE DRAWINGS	DWG.No.
xxxxxxx	xxxxxxx

REV.	DATE	PURPOSE OF ISSUE (P.O.I.)	PREP.	CHKD.	APPR.	AC.
01	18/10/21	For approval	HT	RB	RB	-
00	24/11/20	For approval	HT	RB	RB	-

OWNER:	MC:	CONTRACTOR:

PROJECT: BUSHEHR PETROCHEMICAL COMPANY
MEG PLANT

DRAWING TITLE: 17B11-07A
UCP/LCP/MB GENERAL ARRANGEMENT DRAWING & TERMINAL DETAILS FOR NITROGEN GAS

CONTRACT NO.	SCALE	SIZE	CLASS	PHASE
52-98/445	XX	A0	1	P

DOCUMENT NO.	PROJECT	AREA	PHASE	MRQ No.	DIS.	DOC.	SEQ.	SHEET	REV. NO.
BU-20-10-302-0-200-000								4 OF 6	01

THIS DOCUMENT IS UNCLASSIFIED AND IS AVAILABLE FOR REPRODUCTION OR DISTRIBUTION IN WHOLE OR IN PART WITHOUT LIMITATION.

LP-C1002-01

FRONT SIDE (OUTSIDE) VIEW

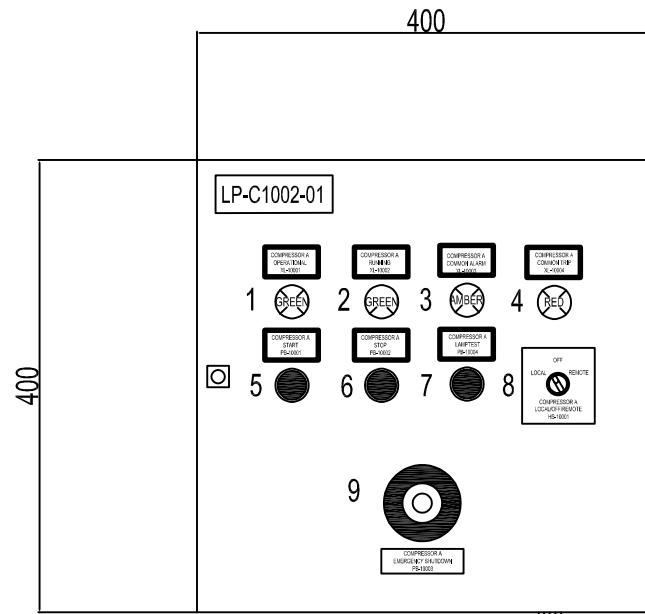

EARTHING BOSS M10

FRONT SIDE (INSIDE) VIEW

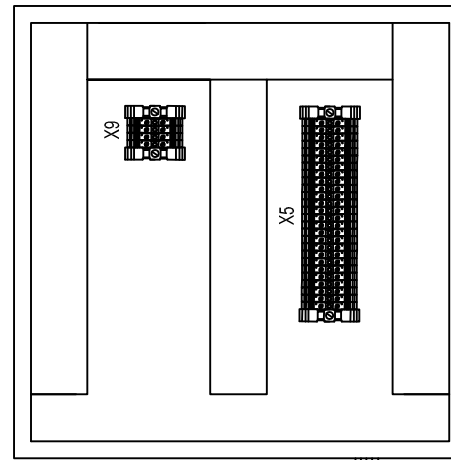

EARTHING BOSS M10

SIDE (OUTSIDE) VIEW

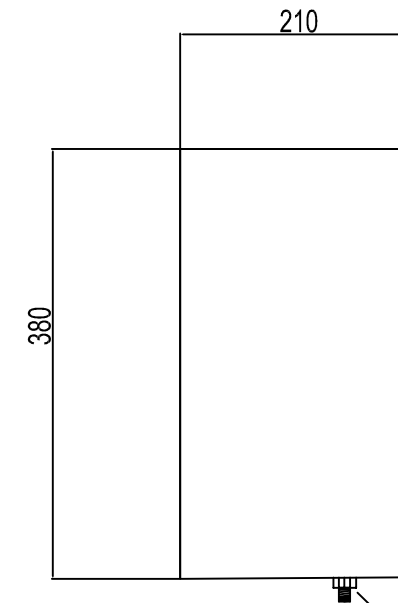

EARTHING BOSS M10

BOTTOM VIEW

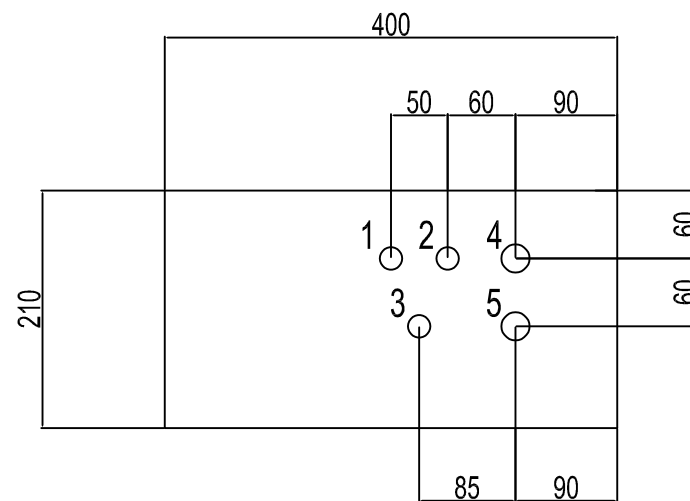

- 1 = ESD multicore cable - M20
- 2 = Spare plug - M20
- 3 = Breather / Drain - M20
- 4 = Pushbutton / Lamps multicore cable - M25
- 5 = Spare plug - M25

GLAND ENTRY DETAILS

- M20: 1x (Breather)
- M20: 2x
- M25: 2x

Nameplate for junction box

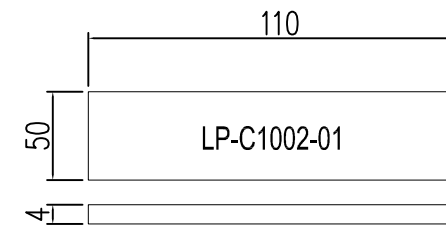

Nameplate for components on JB door (Typical)

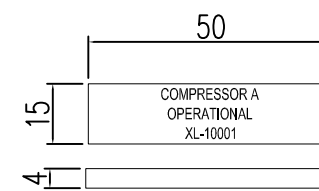

Modify the MC logo

GENERAL NOTES

1. Panel material: SS316
2. Ingress protection: IP-65
3. Panel dimensions: 400x400x210 mm
4. Area classification: Eex 'e' (RAL 6021) Green
5. All spare holes are plugged with certified plugs

REFERENCE DRAWINGS	DWG.No.
xxxxxxx	xxxxxxx

01	18/10/21	For approval	HT	RB	RB	-		
00	24/11/20	For approval	HT	RB	RB	-		
REV.	DATE	PURPOSE OF ISSUE (P.O.I)	PREP.	CHKD.	APPR.	AC.		
OWNER:			MC:			CONTRACTOR:		
PROJECT: BUSHEHR PETROCHEMICAL COMPANY MEG PLANT			DRAWING TITLE: 17B11-07A			CONTRACT NO. 52-28/445		
SCALE: XX			SIZE: A0			CLASS: 1		
DOCUMENT NO. 00-00-00-00-00-00			PROJECT AREA PHASE			DIS. DOC. SEQ. SHEET		
OWNER DOC. NO. BU-20-VD-303-IN-DWG-0039			REV. NO. 6 OF 6			01		

THIS DRAWING IS THE PROPERTY OF AIRPACK. IT IS TO BE USED ONLY FOR THE PROJECT AND SITE SPECIFICALLY MENTIONED THEREIN. IT IS NOT TO BE REPRODUCED OR COPIED IN ANY FORM OR BY ANY MEANS WITHOUT THE WRITTEN PERMISSION OF AIRPACK.