









OWNER:  شرکت مست و سویی گیسو ایران (سهامی خاص) SSTI	<b>BUSHEHR PETROCHEMICAL COMPANY MEG PLANT</b>							EPC CONTRACTOR:  Chagalesh-Enerchimi-Steam Joint Venture BUPC-MEG PLANT PROJECT	
MC :  شرکت مست و سویی گیسو ایران (سهامی خاص) SSTI	<b>UCP/LCP/JB GENERAL ARRANGEMENT DRAWING &amp; TERMINAL DETAILS FOR EMERGENCY INSTRUMENT AIR COMPRESSOR INCL. BOM</b>							 Netherlands	
<b>Owner Document Number: 17811-07B</b>	<b>Project</b> BU	<b>Area</b> 20	<b>Phase</b> VD	<b>Unit</b> 303	<b>Dis.</b> IN	<b>Doc.</b> DWG	<b>Seq.</b> 0089	<b>Contract No: 52-98/445</b>	
								<b>Rev.:</b> 01	<b>Page</b> 1 of 8

## UCP/LCP/JB GENERAL ARRANGEMENT DRAWING & TERMINAL DETAILS FOR EMERGENCY INSTRUMENT AIR COMPRESSOR INCL. BOM

<del>01</del>	<del>19/10/2021</del>	<del>For approval</del>		<del>HT</del>	<del>RB</del>	<del>KP</del>	
00	24/11/2020	For approval		HT	RB	KP	
<b>Rev.</b>	<b>Date</b>	<b>Purpose of Issue</b>		<b>Prepared</b>	<b>Checked</b>	<b>Approved</b>	<b>AC Code</b>
						<b>Class: 1</b>	<b>Phase: P</b>

<b>OWNER:</b>  شرکت مست و سوبی نوسا ایرانیا (سهای ناس)	<b>BUSHEHR PETROCHEMICAL COMPANY MEG PLANT</b>						<b>EPC CONTRACTOR</b>  Chagalesh-Enerchimi-Steam Joint Venture BUPC-MEG PLANT PROJECT		
	<b>UCP/LCP/JB GENERAL ARRANGEMENT DRAWING &amp; TERMINAL DETAILS FOR EMERGENCY INSTRUMENT AIR COMPRESSOR INCL. BOM</b>							 Netherlands	
<b>MC :</b>  شرکت مست و سوبی نوسا ایرانیا (سهای ناس)	Project	Area	Phase	Unit	Dis.	Doc.	Seq.	Contract No: 52-98/445	
<b>Owner Document Number:</b> 17811-07B	BU	20	VD	303	IN	DWG	0089	Rev.:	Page
								01	2 of 8

### TABULATION OF REVISED PAGES

Page	D00	D01	D02	D03	D04
1.	X	<del>X</del>			
2.	X	<del>X</del>			
3.	X	<del>X</del>			
4.	X	<del>X</del>			
5.	X	<del>X</del>			
6.	X	<del>X</del>			
7.	X	<del>X</del>			
8.	X	<del>X</del>			
9.	X				
10.	X				
11.	X				
12.	X				
13.	X				
14.					
15.					
16.					
17.					
18.					
19.					
20.					
21.					
22.					
23.					
24.					
25.					
26.					
27.					
28.					
29.					
30.					
31.					
32.					
33.					
34.					

Page	D00	D01	D02	D03	D04
35.					
36.					
37.					
38.					
39.					
40.					
41.					
42.					
43.					
44.					
45.					
46.					
47.					
48.					
49.					
50.					
51.					
52.					
53.					
54.					
55.					
56.					
57.					
58.					
59.					
60.					
61.					
62.					
63.					
64.					
65.					
66.					
67.					



UCP-C7080-01

FRONT SIDE (OUTSIDE) VIEW

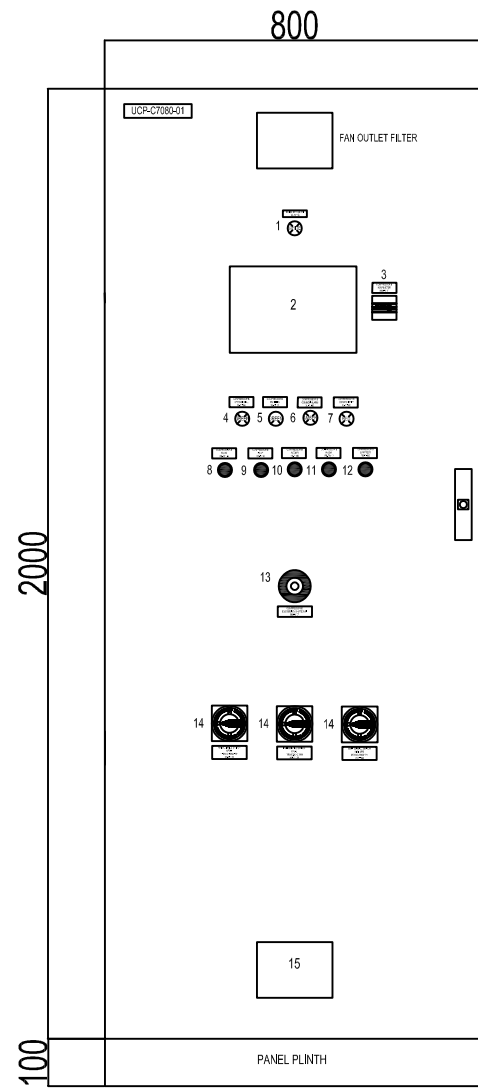

FRONT SIDE (INSIDE) VIEW

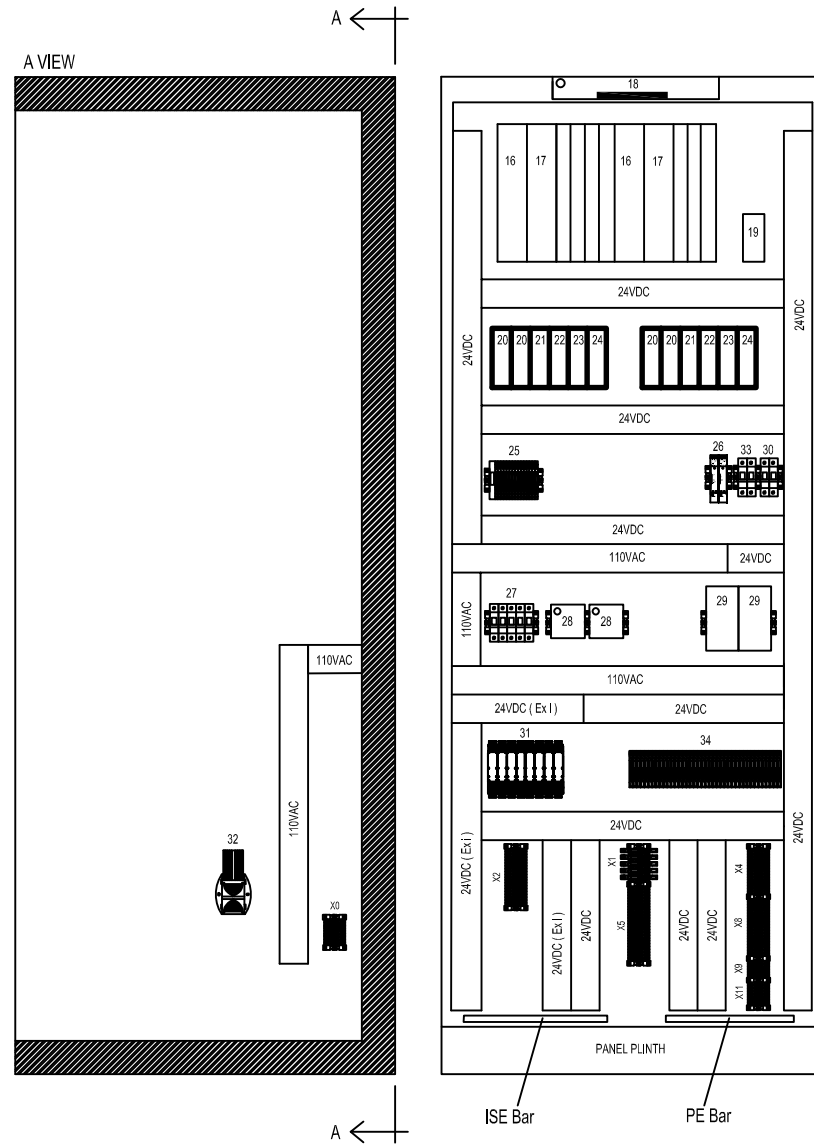

SIDE (OUTSIDE) VIEW

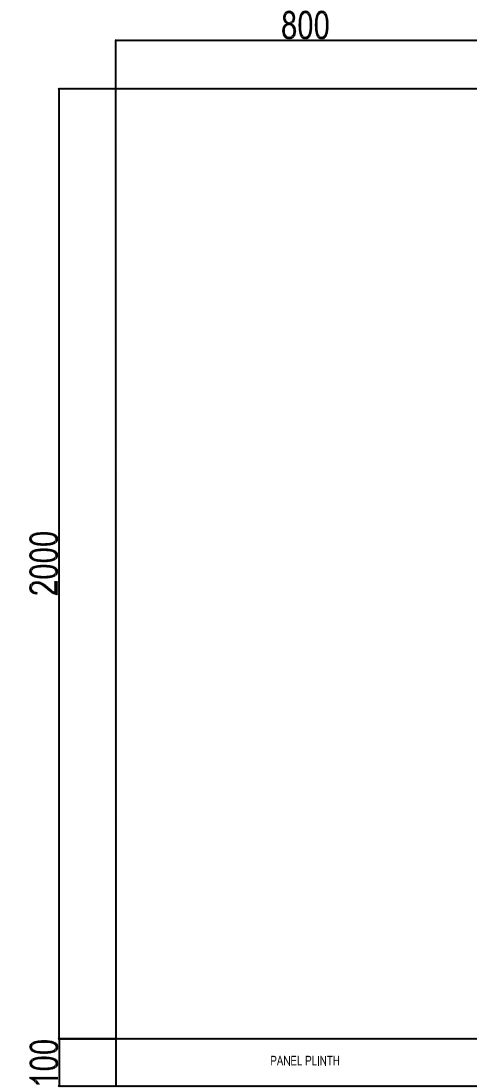

GENERAL NOTES

1. Panel material: Painted sheet steel (RAL7035)
2. Ingress protection: IP-42
3. Panel dimensions: 2100x800x800 mm
4. Area classification: Safe area
5. Drawing pocket will be included: (A3 format)

REFERENCE DRAWINGS

XXXXXXXX

DWG.No.

XXXXXXXX

Nameplate for UCP panel

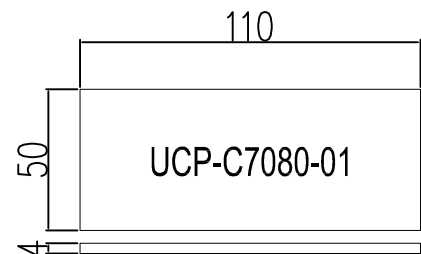

Nameplate for components on panel door  
(Typical)

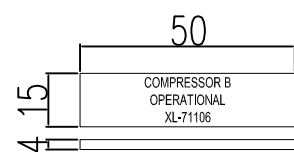

PLINTH FIXING HOLES

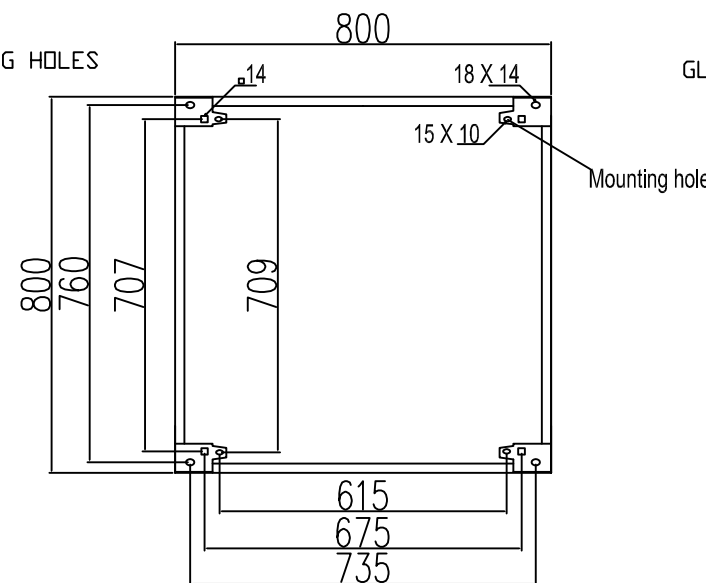

GLAND PLATE MOUNTING DETAILS

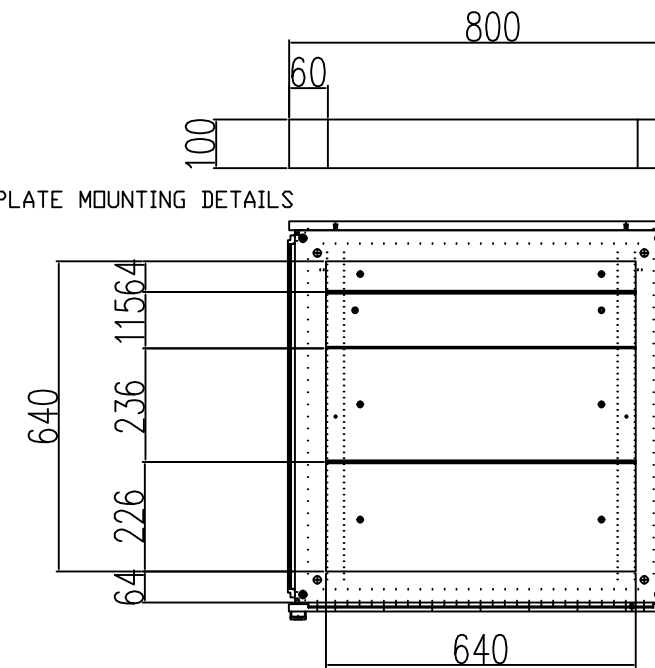

Modify the MC logo

01	19/10/21	For approval	HT	RB	RB	-
00	24/11/20	For approval	HT	RB	RB	-
REV.	DATE	PURPOSE OF ISSUE (P.00)	PREP.	CHKD.	APPR.	AC.
OWNER:			MC:		CONTRACTOR:	
PROJECT: BUSHEHR PETROCHEMICAL COMPANY MEG PLANT						
DRAWING TITLE: 17811-07B						
UCP/ACP/AB GENERAL ARRANGEMENT DRAWING & TERMINAL DETAILS FOR EMERGENCY INTERMEDIATE AIR COMPRESSOR						
CONTRACT NO.	SCALE	SIZE	CLASS	PHASE		
52-28/445	XX	A0	1	P		
DOCUMENT NO.	PROJECT	AREA	PHASE	MRQ No.	DIS.	DOC. SEQ.
OWNER DOC. NO.:	BU-20-VD-303-IN-DWG-0089					2 OF 6

# JNDX-C7080-01

FRONT SIDE (OUTSIDE) VIEW

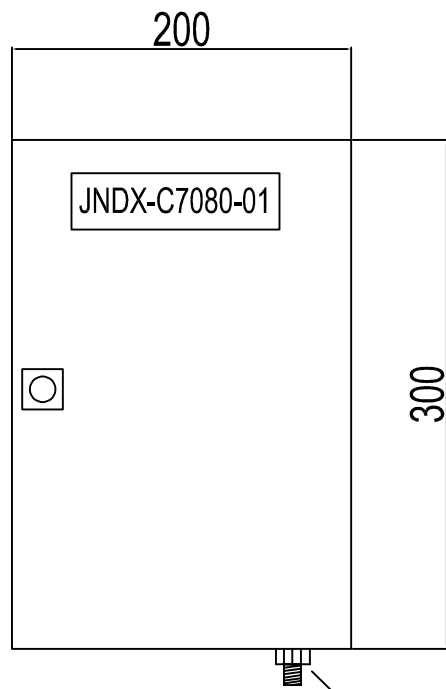

EARTHING  
BOSS  
M10

FRONT SIDE (INSIDE) VIEW

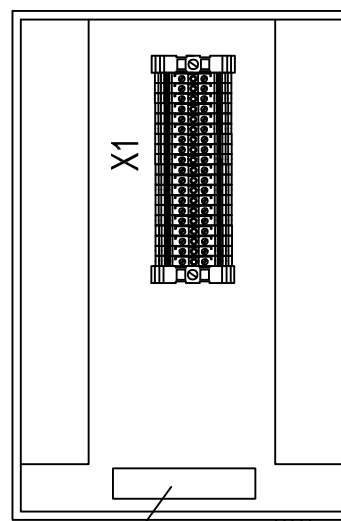

ISE Bar

EARTHING  
BOSS  
M10

SIDE (OUTSIDE) VIEW

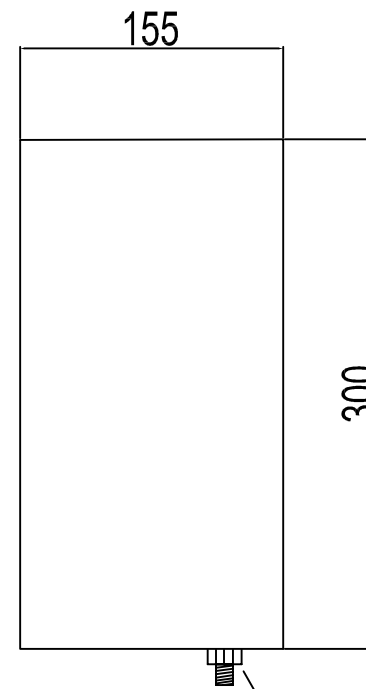

EARTHING  
BOSS  
M10

BOTTOM VIEW

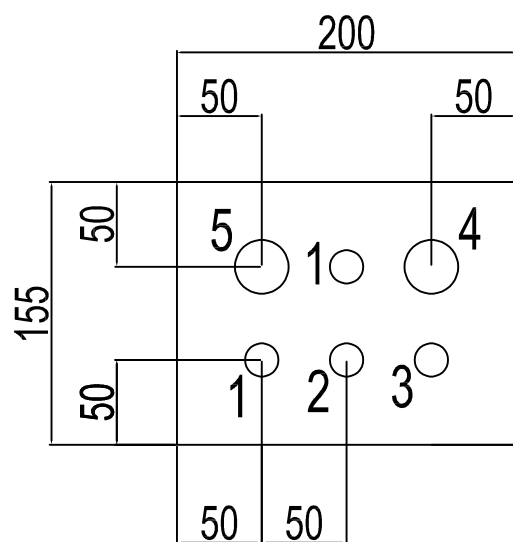

- 1 = Solenoid cable - M20
- 2 = Spare plug - M20
- 3 = Breather / Drain - M20
- 4 = Solenoid multipair cable - M32
- 5 = Spare plug - M32

## GLAND ENTRY DETAILS

- M20: 1x (Breather)
- M20: 3x
- M32: 2x

## Nameplate for junction box

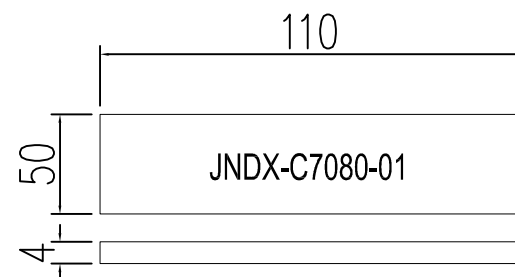

Modify the MC logo

### GENERAL NOTES

1. Panel material: SS316
2. Ingress protection: IP-65
3. Panel dimensions: 200x300x155 mm
4. Area classification: Eex 'e' (RAL 6021) Green
5. All spare holes are plugged with certified plugs

#### REFERENCE DRAWINGS

xxxxxxx

#### DWG.No.

xxxxxxx

REV	DATE	PURPOSE OF ISSUE (P.O.I)	PREP	CHKD	APPR	AC
01	19/10/21	For approval	HT	RB	RB	-
00	24/11/20	For approval	HT	RB	RB	-

OWNER:	MC:	CONTRACTOR:

PROJECT: BUSHEHR PETROCHEMICAL COMPANY  
MEG PLANT

DRAWING TITLE: 17811-07B

CONTRACT NO. 52-28/445  
SCALE XX  
SIZE A0  
CLASS 1  
PHASE P

DOCUMENT NO.	PROJECT	AREA	PHASE	MRQ No.	DIS.	DOC.	SEQ.	SHEET	REV. NO.
BU-20-VD-303-IN-DWG-0089								3 OF 6	00

JIAX-C7080-01

FRONT SIDE (OUTSIDE) VIEW

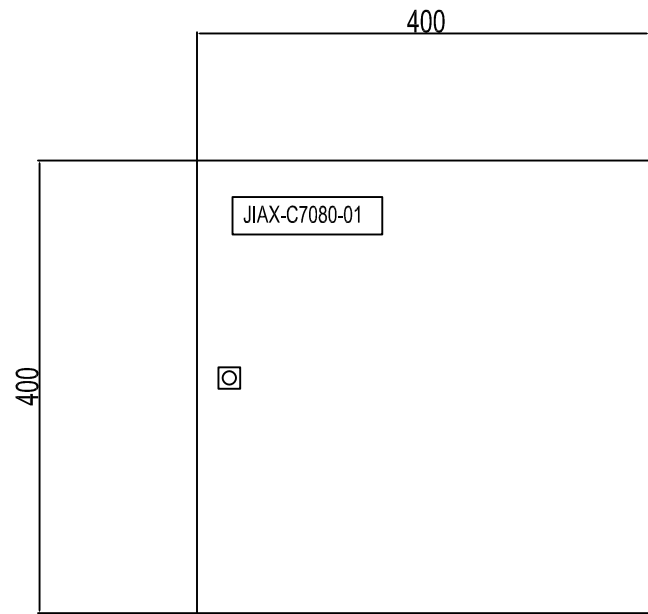

EARTHING BOSS M10

FRONT SIDE (INSIDE) VIEW

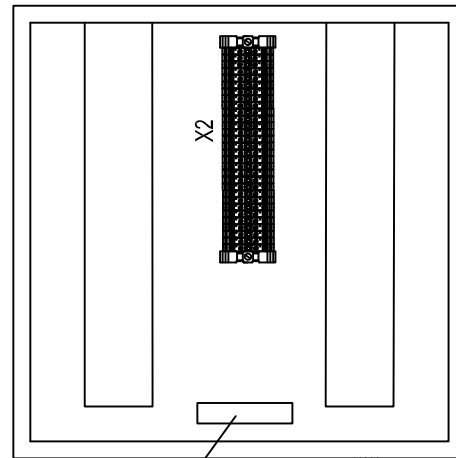

PE Bar

EARTHING BOSS M10

SIDE (OUTSIDE) VIEW

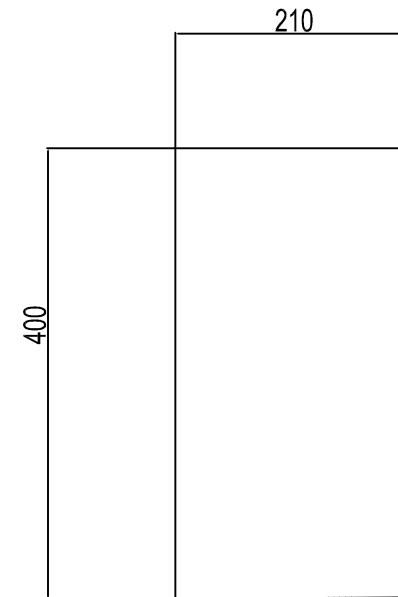

EARTHING BOSS M10

BOTTOM VIEW

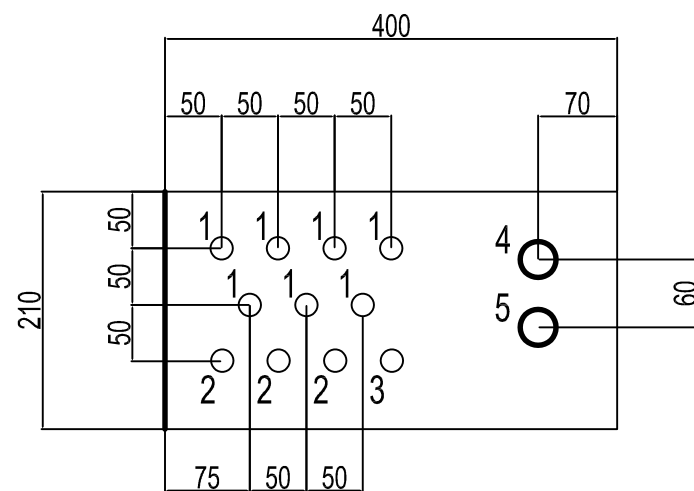

- 1 = Transmitter cable - M20
- 2 = Spare plug - M20
- 3 = Breather / Drain - M20
- 4 = Transmitter multipair cable - M32
- 5 = Spare plug - M32

GLAND ENTRY DETAILS

- M20: 1x (Breather)
- M20: 10x
- M32: 2x

Nameplate for junction box

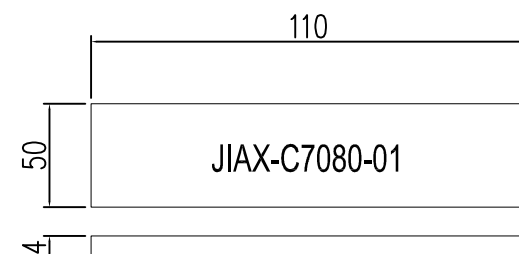

Modify the MC logo

GENERAL NOTES

1. Panel material: SS316
2. Ingress protection: IP-65
3. Panel dimensions: 400x400x210 mm
4. Area classification: Eex 'I' (RAL 5015) Blue
5. All spare holes are plugged with certified plugs

REFERENCE DRAWINGS	DWG.No.
xxxxxxx	xxxxxxx

REV.	DATE	PURPOSE OF ISSUE (P.O.I.)	PREP.	CHKD.	APPR.	AC.
01	19/10/21	For approval	HT	RB	RB	-
00	24/11/20	For approval	HT	RB	RB	-

OWNER:	MC:	CONTRACTOR:

PROJECT: BUSHEHR PETROCHEMICAL COMPANY MEG PLANT									
DRAWING TITLE: 17B11-07B									
CONTRACT NO. 52-95/445									
SCALE XX									
SIZE A0									
CLASS 1									
PHASE P									
DOCUMENT NO.	PROJECT	AREA	PHASE	MRQ No.	DIS.	DOC.	SEQ.	SHEET	REV. NO.
BU-20-10-303-0-000-0089								4 OF 6	00

BU-20-VD-303-IN-DWG-0089



LP-C7080-01

FRONT SIDE (OUTSIDE) VIEW

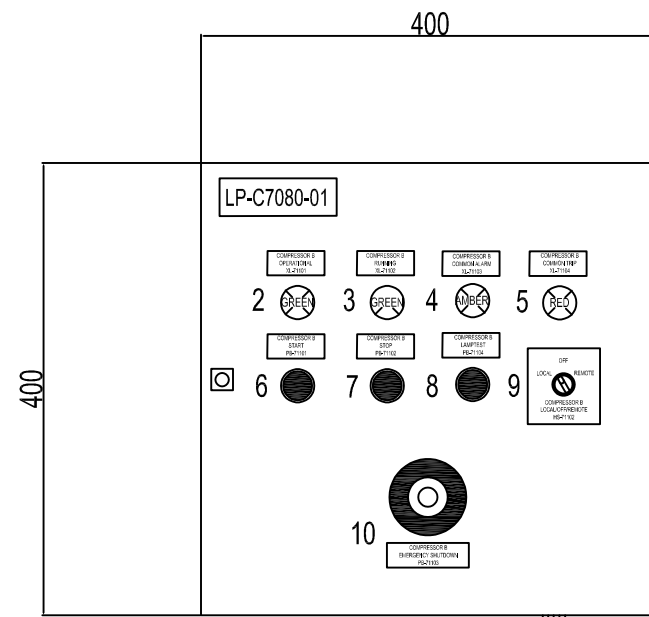

EARTHING BOSS M10

FRONT SIDE (INSIDE) VIEW

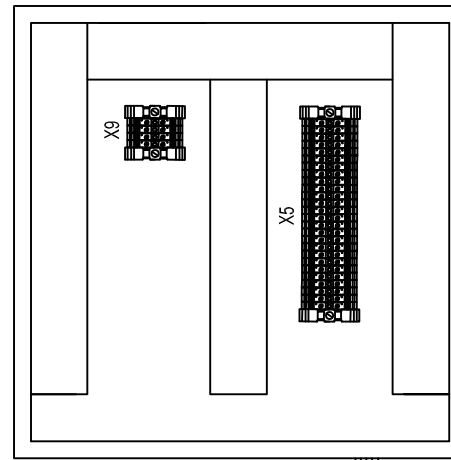

EARTHING BOSS M10

SIDE (OUTSIDE) VIEW

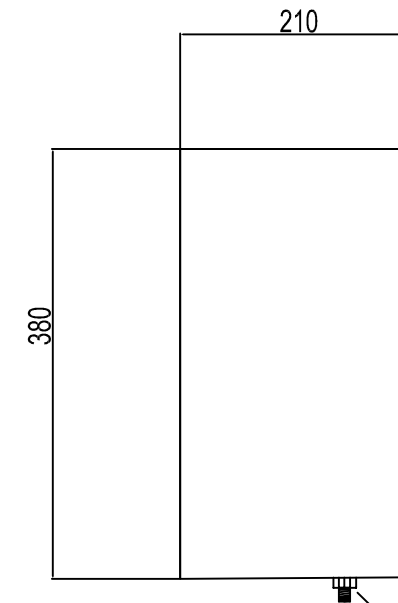

EARTHING BOSS M10

BOTTOM VIEW

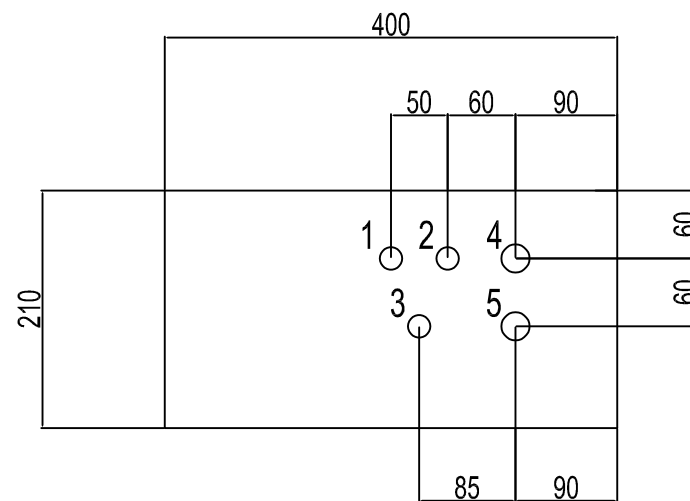

- 1 = ESD multicore cable - M20
- 2 = Spare plug - M20
- 3 = Breather / Drain - M20
- 4 = Pushbutton / Lamps multicore cable - M25
- 5 = Spare plug - M25

GLAND ENTRY DETAILS

- M20: 1x (Breather)
- M20: 2x
- M25: 2x

Nameplate for junction box

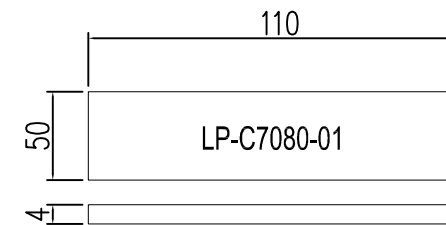

Nameplate for components on JB door (Typical)

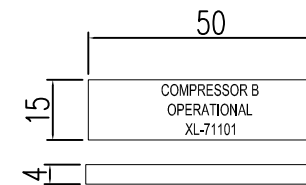

Modify the MC logo

GENERAL NOTES

1. Panel material: SS316
2. Ingress protection: IP-65
3. Panel dimensions: 400x400x210 mm
4. Area classification: Eex 'e' (RAL 6021) Green
5. All spare holes are plugged with certified plugs

REFERENCE DRAWINGS

XXXXXXXX

DWG.No.

XXXXXXXX

REV	DATE	PURPOSE OF ISSUE (P.O.I)	PREP	CHKD	APPR	AC
01	19/10/21	For approval	HT	RB	RB	-
00	24/11/20	For approval	HT	RB	RB	-

OWNER:	MC:	CONTRACTOR:

PROJECT: BUSHEHR PETROCHEMICAL COMPANY MEG PLANT

DRAWING TITLE: 17811-07B

UOP/APP/38 GENERAL ARRANGEMENT DRAWING & TERMINAL DETAILS FOR EMERGENCY DISTURB AIR COMPRESSOR

CONTRACT NO.	SCALE	SIZE	CLASS	PHASE
52-98/445	XX	A0	1	P

DOCUMENT NO.	PROJECT	AREA	PHASE	MRQ No.	DIS.	DOC.	SEQ.	SHEET	REV. NO.
BU-20-10-303-0-000-000	BU-20-VD-303-IN-DWG-0089							6 OF 6	00