





OWNER:  شرکت مست و سویی گیس ایرانیان (سهامی خاص)	BUSHEHR PETROCHEMICAL COMPANY MEG PLANT							EPC CONTRACTOR:  Chagalesh-Enerchimi-Steam Joint Venture BUPC-MEG PLANT PROJECT	
	COMPRESSOR MOTOR OUTLINE DRAWING & TERMINAL BOX WIRING DIAGRAM FOR NITROGEN GAS BOOSTER							 Netherlands	
MC :  شرکت مست و سویی گیس ایرانیان (سهامی خاص)	Project	Area	Phase	Unit	Dis.	Doc.	Seq.	Contract No: 52-98/445	
Owner Document Number: 17811-39B	BU	20	VD	303	EL	DWG	0101	Rev.:	Page
								00	1 of 5

COMPRESSOR MOTOR OUTLINE DRAWING & TERMINAL BOX WIRING DIAGRAM FOR EMERGENCY INSTRUMENT AIR COMPRESSOR

00	08/12/2020	For approval		KP	LdM	JR	
Rev.	Date	Purpose of Issue		Prepared	Checked	Approved	AC Code
						Class: 1	Phase: P

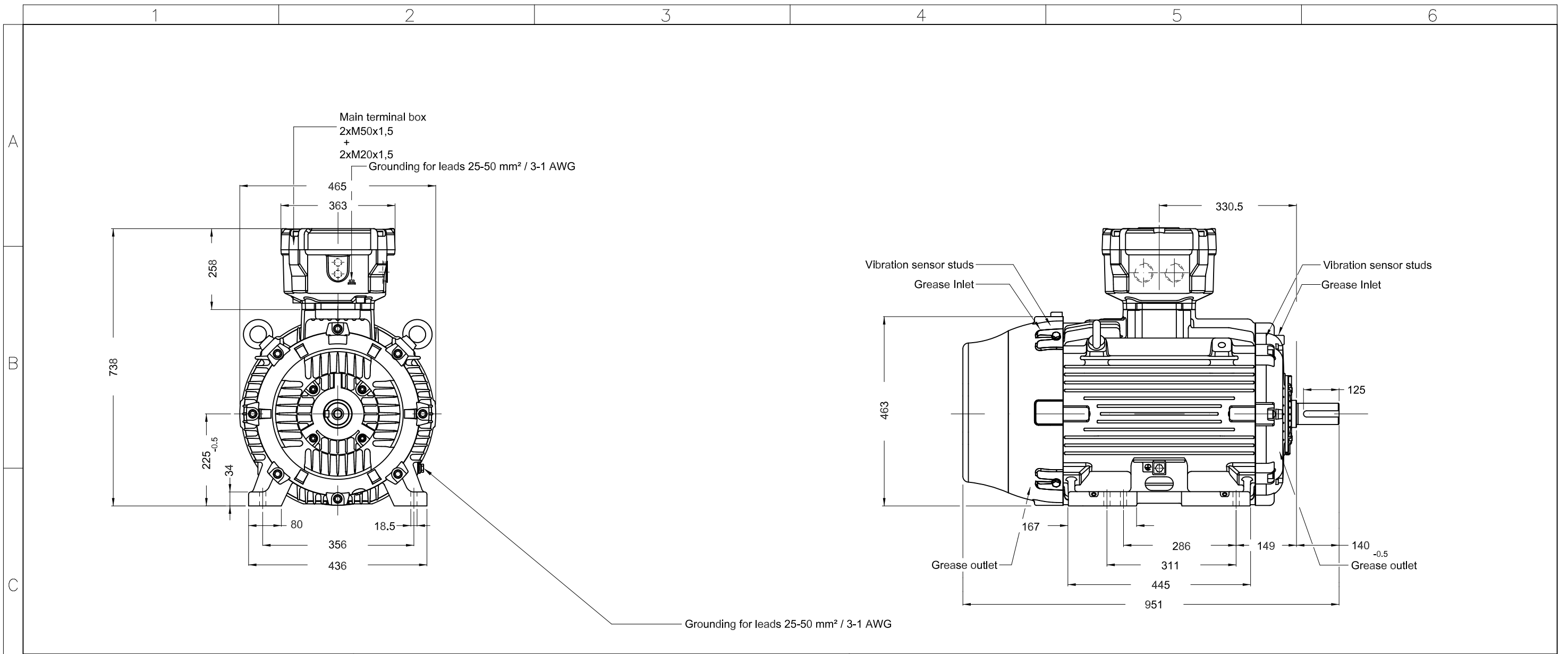

1	2	3	4	5	6
A					
B					
C					
D					
E					

Tropicalized internal painting
DE roller bearing
Shaft locking device
Shaft material - AISI/SAE 4140
SPM studs
Color RAL 5010
Painting plan 205P
Mounting B3T

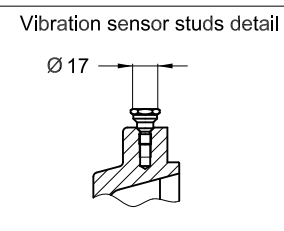
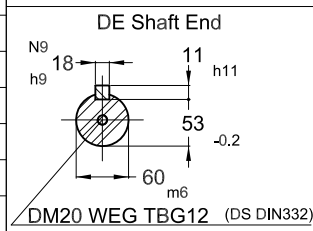



45 kW 04 Poles 50 Hz										A	
ECM	LOC	SUMMARY OF MODIFICATIONS					EXECUTED	CHECKED	RELEASED	DATE	VER
EXECUTED	PIRWBUSER	THREE PH. MOTOR W22Xdb IE4					PREVIEW	WDD	SHEET	1 / 1	
CHECKED		FRAME 225S/M IP56 TEFC									
RELEASED											
REL DT.		WMO	Jaragua do Sul	Product Engineering							

Dimensional drawing subject to change. We reserve the right to change constructional details.
 * Detail out of scale.

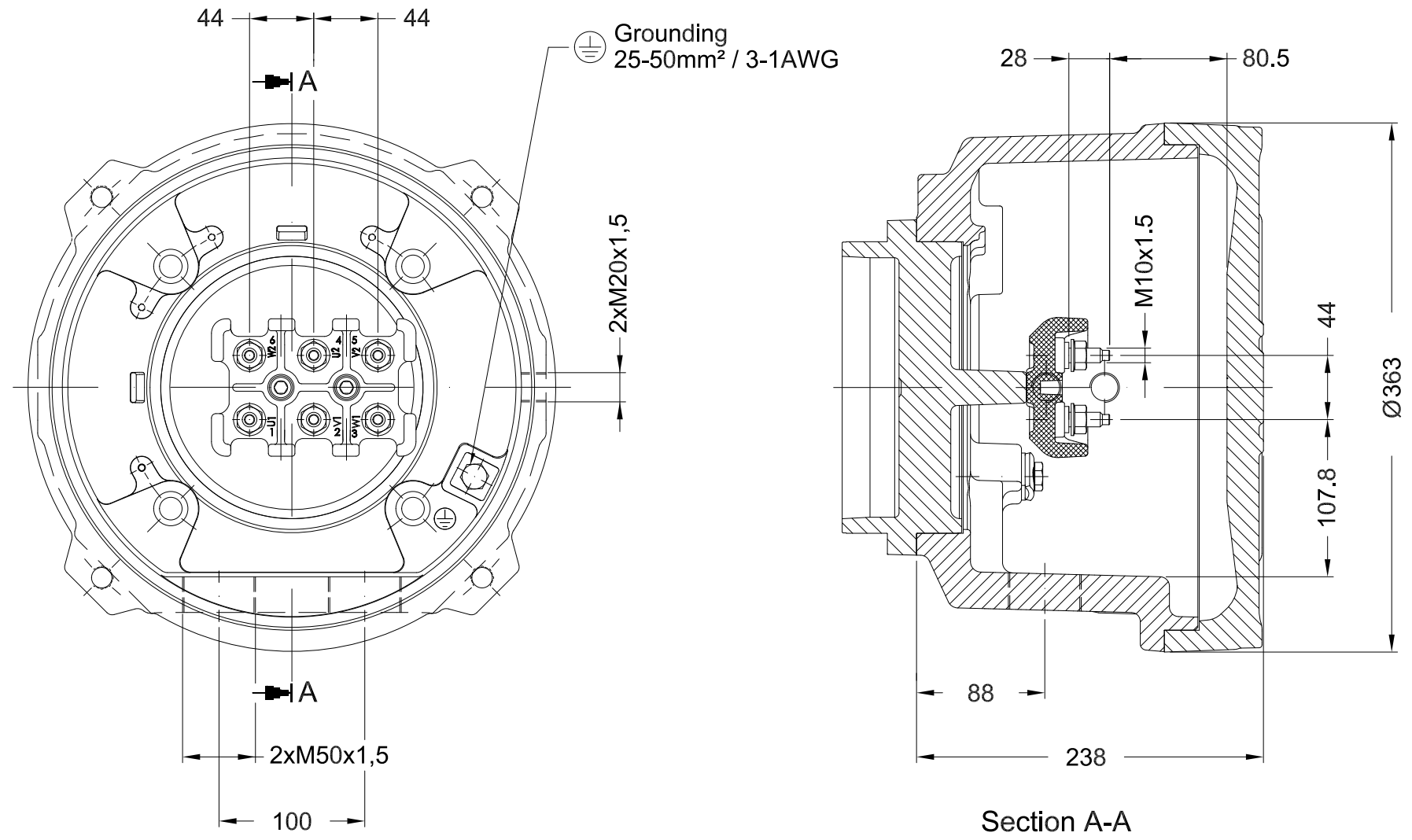
A
B
C
D
E

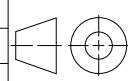

Section A-A

					ESC	1:4			
ECM	LOC	SUMMARY OF MODIFICATIONS			EXECUTED	CHECKED	RELEASED	DATE	VER
EXECUTED	YDAMHUIS	 MAIN TERMINAL BOX FRAME 225S/M			PREVIEW WCD				
CHECKED									
RELEASED									
REL DT.									
					SHEET	01 / 03			

THIS IS AN UPDATED REVISION, THE PREVIOUS ONE MUST BE DISREGARDED.

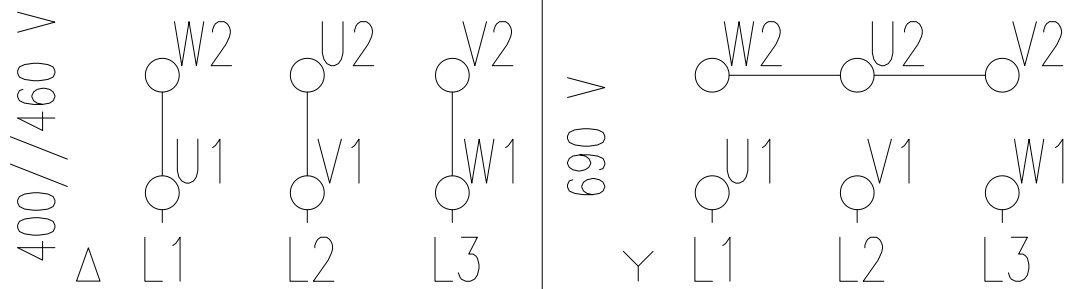

A

B

C

D

E

		ORIGINAL ISSUE		JESSICA	PATRICIA	CASTELLA	30.10.2018	00
ECM	LOC	RESUMO MODIFICAÇÃO		EXECUTADO	VERIFICADO	LIBERADO	DATA	VER
EXEC. /EXECUTED	JESSICA	SUMMARY OF MODIFICATIONS		EXECUTED	CHECKED	RELEASED	DATE	VER
VERIF. /CHECKED	PATRICIA	LOW VOLTAGE - CONNECTION DIAGRAM		400/690//460-6				
LIBER. /RELEASED	CASTELLA	MOTOR WITH 06 CABLES		IEC 00				
DATA LB /REL DT	30.10.2018	WMO	JARAGUÁ DO SUL	ADMINISTRAÇÃO DE VENDAS	FOLHA /SHEET	1 / 1		